



# *Clavinova*<sup>®</sup>

---

Owner's Manual  
Mode d'emploi

CLP-725

English

Français

Before using the instrument, be sure to read "PRECAUTIONS" on pages 5-6.  
For information on assembling the instrument, refer to the instructions on page 31.

Avant d'utiliser l'instrument, lisez attentivement la section « PRÉCAUTIONS D'USAGE »  
aux pages 5 et 6.  
Pour plus d'informations sur l'assemblage de l'instrument, reportez-vous aux instructions  
figurant en page 31.

EN

FR



# FCC INFORMATION (U.S.A.)

## 1. IMPORTANT NOTICE: DO NOT MODIFY THIS UNIT!

This product, when installed as indicated in the instructions contained in this manual, meets FCC requirements. Modifications not expressly approved by Yamaha may void your authority, granted by the FCC, to use the product.

## 2. IMPORTANT:

When connecting this product to accessories and/or another product use only high quality shielded cables. Cable/s supplied with this product MUST be used. Follow all installation instructions. Failure to follow instructions could void your FCC authorization to use this product in the USA.

## 3. NOTE:

This product has been tested and found to comply with the requirements listed in FCC Regulations, Part 15 for Class "B" digital devices. Compliance with these requirements provides a reasonable level of assurance that your use of this product in a residential environment will not result in harmful interference with other electronic devices. This equipment generates/uses radio frequencies and, if not installed and used according to the instructions found in the users manual, may cause interference harmful to the operation of other electronic devices. Com-

pliance with FCC regulations does not guarantee that interference will not occur in all installations. If this product is found to be the source of interference, which can be determined by turning the unit "OFF" and "ON", please try to eliminate the problem by using one of the following measures:

Relocate either this product or the device that is being affected by the interference.

Utilize power outlets that are on different branch (circuit breaker or fuse) circuits or install AC line filter/s.

In the case of radio or TV interference, relocate/reorient the antenna. If the antenna lead-in is 300 ohm ribbon lead, change the lead-in to co-axial type cable.

If these corrective measures do not produce satisfactory results, please contact the local retailer authorized to distribute this type of product. If you can not locate the appropriate retailer, please contact Yamaha Corporation of America, Electronic Service Division, 6600 Orangethorpe Ave, Buena Park, CA90620

The above statements apply ONLY to those products distributed by Yamaha Corporation of America or its subsidiaries.

\* This applies only to products distributed by Yamaha Corporation of America.

(class B)

## COMPLIANCE INFORMATION STATEMENT (Supplier's declaration of conformity procedure)

Responsible Party : Yamaha Corporation of America

Address : 6600 Orangethorpe Ave., Buena Park, Calif. 90620

Telephone : 714-522-9011

Type of Equipment : Digital Piano

Model Name : CLP-725

This device complies with Part 15 of the FCC Rules.

Operation is subject to the following two conditions:

- 1) this device may not cause harmful interference, and
- 2) this device must accept any interference received including interference that may cause undesired operation.

\* This applies only to products distributed by Yamaha Corporation of America.

(FCC SDoC)

## For AC adaptor

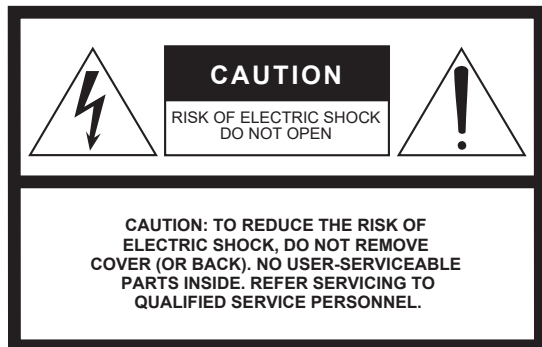

### Explanation of Graphical Symbols



The lightning flash with arrowhead symbol within an equilateral triangle is intended to alert the user to the presence of uninsulated “dangerous voltage” within the product’s enclosure that may be of sufficient magnitude to constitute a risk of electric shock to persons.



The exclamation point within an equilateral triangle is intended to alert the user to the presence of important operating and maintenance (servicing) instructions in the literature accompanying the product.

## IMPORTANT SAFETY INSTRUCTIONS

- 1 Read these instructions.
- 2 Keep these instructions.
- 3 Heed all warnings.
- 4 Follow all instructions.
- 5 Do not use this apparatus near water.
- 6 Clean only with dry cloth.
- 7 Do not block any ventilation openings. Install in accordance with the manufacturer’s instructions.
- 8 Do not install near any heat sources such as radiators, heat registers, stoves, or other apparatus (including amplifiers) that produce heat.
- 9 Do not defeat the safety purpose of the polarized or grounding-type plug. A polarized plug has two blades with one wider than the other. A grounding type plug has two blades and a third grounding prong. The wide blade or the third prong are provided for your safety. If the provided plug does not fit into your outlet, consult an electrician for replacement of the obsolete outlet.
- 10 Protect the power cord from being walked on or pinched particularly at plugs, convenience receptacles, and the point where they exit from the apparatus.
- 11 Only use attachments/accessories specified by the manufacturer.
- 12 Use only with the cart, stand, tripod, bracket, or table specified by the manufacturer, or sold with the apparatus. When a cart is used, use caution when moving the cart/apparatus combination to avoid injury from tip-over.
- 13 Unplug this apparatus during lightning storms or when unused for long periods of time.
- 14 Refer all servicing to qualified service personnel. Servicing is required when the apparatus has been damaged in any way, such as power-supply cord or plug is damaged, liquid has been spilled or objects have fallen into the apparatus, the apparatus has been exposed to rain or moisture, does not operate normally, or has been dropped.



### WARNING

TO REDUCE THE RISK OF FIRE OR ELECTRIC SHOCK, DO NOT EXPOSE THIS APPARATUS TO RAIN OR MOISTURE.

(UL60065\_03)

# PRECAUTIONS

## PLEASE READ CAREFULLY BEFORE PROCEEDING

Please keep this manual in a safe and handy place for future reference.

### For the AC adaptor



#### WARNING

- This AC adaptor is designed for use with only Yamaha electronic instruments. Do not use for any other purpose.
- Indoor use only. Do not use in any wet environments.



#### CAUTION

- When setting up, make sure that the AC outlet is easily accessible. If some trouble or malfunction occurs, immediately turn off the power switch of the instrument and disconnect the AC adaptor from the outlet. When the AC adaptor is connected to the AC outlet, keep in mind that electricity is flowing at the minimum level, even if the power switch is turned off. When you are not using the instrument for a long time, make sure to unplug the power cord from the wall AC outlet.

### For the instrument



#### WARNING

Always follow the basic precautions listed below to avoid the possibility of serious injury or even death from electrical shock, short-circuiting, damages, fire or other hazards. These precautions include, but are not limited to, the following:

#### Power supply/AC adaptor

- Do not place the power cord near heat sources such as heaters or radiators. Also, do not excessively bend or otherwise damage the cord, or place heavy objects on it.
- Only use the voltage specified as correct for the instrument. The required voltage is printed on the name plate of the instrument.
- Use the specified adaptor (page 34) only. Using the wrong adaptor can result in damage to the instrument or overheating.
- Use only the supplied power cord/plug.
- Check the electric plug periodically and remove any dirt or dust which may have accumulated on it.

#### Do not open

- This instrument contains no user-serviceable parts. Do not open the instrument or attempt to disassemble or modify the internal components in any way. If it should appear to be malfunctioning, discontinue use immediately and have it inspected by qualified Yamaha service personnel.

#### Water warning

- Do not expose the instrument to rain, use it near water or in damp or wet conditions, or place on it any containers (such as vases, bottles or glasses) containing liquids which might spill into any openings. If any liquid such as water seeps into the instrument, turn off the power immediately and unplug the power cord from the AC outlet. Then have the instrument inspected by qualified Yamaha service personnel.
- Never insert or remove an electric plug with wet hands.

#### Fire warning

- Do not put burning items, such as candles, on the unit. A burning item may fall over and cause a fire.

#### Using the bench (If included)

- Do not place the bench in an unstable position where it might accidentally fall over.
- Do not play carelessly with or stand on the bench. Using it as a tool or stepladder or for any other purpose might result in accident or injury.
- Only one person should sit on the bench at a time, in order to prevent the possibility of accident or injury.
- If the bench screws become loose due to extensive long-term use, tighten them periodically using the specified tool in order to prevent the possibility of accident or injury.
- Keep special watch over any small children so that they don't fall off the rear of the bench. Since the bench does not have a backrest, unsupervised use may result in accident or injury.

#### If you notice any abnormality

- When one of the following problems occur, immediately turn off the power switch and disconnect the electric plug from the outlet. Then have the device inspected by Yamaha service personnel.
  - The power cord or plug becomes frayed or damaged.
  - It emits unusual smells or smoke.
  - Some object has been dropped into the instrument.
  - There is a sudden loss of sound during use of the instrument.
  - If any cracks or breakages exist on the instrument.

# CAUTION

Always follow the basic precautions listed below to avoid the possibility of physical injury to you or others, or damage to the instrument or other property. These precautions include, but are not limited to, the following:

## Power supply/AC adaptor

- Do not connect the instrument to an electrical outlet using a multiple-connector. Doing so can result in lower sound quality, or possibly cause overheating in the outlet.
- When removing the electric plug from the instrument or an outlet, always hold the plug itself and not the cord. Pulling by the cord can damage it.
- Remove the electric plug from the outlet when the instrument is not to be used for extended periods of time, or during electrical storms.

## Assembly

- Assemble the instrument in the proper sequence by following the assembly instructions in this manual. Also, make sure to tighten the screws regularly. Failure to do so might result in damage to the instrument or even injury.

## Location

- Do not place the instrument in an unstable position where it might accidentally fall over.
- Do not go near the instrument during an earthquake. Strong shaking during an earthquake could cause the instrument to move or tip over, resulting in damage to the instrument or its parts, and possibly causing injury.
- When transporting or moving the instrument, always use two or more people. Attempting to lift the instrument by yourself may damage your back, result in other injury, or cause damage to the instrument itself.
- Before moving the instrument, remove all connected cables, to prevent damage to the cables or injury to anyone who might trip over them.
- When setting up the product, make sure that the AC outlet you are using is easily accessible. If some trouble or malfunction occurs, immediately turn off the power switch and disconnect the plug from the outlet. Even when the power switch is turned off, electricity is still flowing to the product at the minimum level. When you are not using the product for a long time, make sure to unplug the power cord from the wall AC outlet.

## Connections

- Before connecting the instrument to other electronic components, turn off the power for all components. Before turning the power on or off for all components, set all volume levels to minimum.
- Be sure to set the volumes of all components at their minimum levels and gradually raise the volume controls while playing the instrument to set the desired listening level.

## Handling caution

- Do not insert a finger or hand in any gaps on the key cover or instrument. Also take care that the key cover does not pinch your finger.
- Never insert or drop paper, metallic, or other objects into the gaps on the key cover, panel or keyboard. This could cause physical injury to you or others, damage to the instrument or other property, or operational failure.
- Do not rest your weight on, or place heavy objects on the instrument, and do not use excessive force on the buttons, switches or connectors.
- Keep small parts out of the reach of infants. Your children may accidentally swallow them.
- Do not use the instrument/device or headphones for a long period of time at a high or uncomfortable volume level, since this can cause permanent hearing loss. If you experience any hearing loss or ringing in the ears, consult a physician.

Yamaha cannot be held responsible for damage caused by improper use or modifications to the instrument, or data that is lost or destroyed.

Always turn the power off when the instrument is not in use.

Even when the [  ] (Standby/On) switch is in standby status (power indicator is off), electricity is still flowing to the instrument at the minimum level.

When you are not using the instrument for a long time, make sure you unplug the power cord from the wall AC outlet.

The model number, serial number, power requirements, etc., may be found on or near the name plate, which is at the bottom of the unit. You should note this serial number in the space provided below and retain this manual as a permanent record of your purchase to aid identification in the event of theft.

**Model No.**

---

**Serial No.**

---

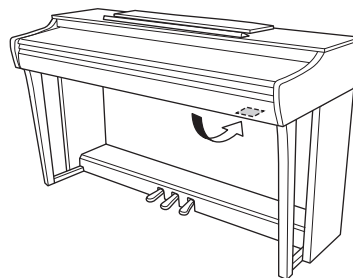

(bottom\_en\_01) The name plate is located on the bottom of the unit.

## NOTICE

To avoid the possibility of malfunction/ damage to the product, damage to data, or damage to other property, follow the notices below.

### ■ Handling

- Do not use the instrument in the vicinity of a TV, radio, stereo equipment, mobile phone, or other electric devices. Otherwise, the instrument, TV, or radio may generate noise.
- When you use the instrument along with an app on your smart device such as a smartphone or tablet, we recommend that you enable “Airplane Mode” on that device in order to avoid noise caused by communication.
- Do not expose the instrument to excessive dust or vibrations, or extreme cold or heat (such as in direct sunlight, near a heater, or in a car during the day) to prevent the possibility of panel disfiguration, damage to the internal components or unstable operation. (Verified operating temperature range: 5° – 40°C, or 41° – 104°F.)
- Do not place vinyl, plastic or rubber objects on the instrument, since this might discolor the panel or keyboard.
- In the case of a model with a polished finish, bumping the surface of the instrument with metal, porcelain, or other hard objects can cause the finish to crack or peel. Use caution.

### ■ Maintenance

- When cleaning the instrument, use a soft and dry/slightly damp cloth. Do not use paint thinners, solvents, alcohol, cleaning fluids, or chemical-impregnated wiping cloths.
- In the case of a model with a polished finish, gently remove dust and dirt with a soft cloth. Do not wipe too hard since small particles of dirt can scratch the instrument’s finish.
- During extreme changes in temperature or humidity, condensation may occur and water may collect on the surface of the instrument. If water is left, the wooden parts may absorb the water and be damaged. Make sure to wipe any water off immediately with a soft cloth.

### ■ Saving data

- Some of the data of this instrument (page 29) are retained when the power is turned off. However, the saved data may be lost due to some failure, an operation mistake, etc. Save your important data onto an external device such as a computer (page 29).

## Information

### ■ About copyrights

- Copying of the commercially available musical data including but not limited to MIDI data and/or audio data is strictly prohibited except for your personal use.
- This product incorporates and bundles contents in which Yamaha owns copyrights or with respect to which Yamaha has license to use others’ copyrights. Due to copyright laws and other relevant laws, you are NOT allowed to distribute media in which these contents are saved or recorded and remain virtually the same or very similar to those in the product.
  - \* The contents described above include a computer program, Accompaniment Style data, MIDI data, WAVE data, voice recording data, a score, score data, etc.
  - \* You are allowed to distribute medium in which your performance or music production using these contents is recorded, and the permission of Yamaha Corporation is not required in such cases.

### ■ About functions/data bundled with the instrument

- Some of the preset songs have been edited for length or arrangement, and may not be exactly the same as the original.

### ■ About this manual

- The illustrations as shown in this manual are for instructional purposes only, and may appear somewhat different from those on your instrument.
- The letters at the end of the model name (such as “B,” “PE”) indicate the color or finish of the instrument. Since they simply indicate the appearance, these letters are omitted in this manual.
- Windows is a registered trademark of Microsoft® Corporation in the United States and other countries.
- iPad and iPhone are trademarks of Apple Inc., registered in the U.S. and other countries.
- Android™ is a trademark of Google LLC.
- The company names and product names in this manual are the trademarks or registered trademarks of their respective companies.

### ■ Tuning

- Unlike an acoustic piano, this instrument does not need to be tuned by an expert (although the pitch can be user-adjusted to match other instruments). This is because the pitch of digital instruments is always maintained perfectly.

# Table of Contents

<b>PRECAUTIONS .....</b>	<b>5</b>
<b>About the Manuals .....</b>	<b>9</b>
<b>Included Accessories .....</b>	<b>9</b>
<b>Panel Controls and Terminals .....</b>	<b>10</b>

## Basic Operations

---

<b>Setting Up .....</b>	<b>11</b>
Key Cover .....	11
Music Rest .....	11
Turning the Power On.....	12
Auto Power Off Function.....	12
Using Headphones .....	13
<b>Playing the Piano.....</b>	<b>14</b>
Using the Pedals.....	14
Turning the VRM Effect On/Off.....	14
Intelligent Acoustic Control (IAC).....	15
Grand Expression Modeling.....	15
Turning the Operation Confirmation Sounds On/Off.....	16
Changing the Touch Sensitivity .....	16
Using the Metronome.....	17

## Advanced Operations

---

<b>Playing Various Musical Instrument Sounds (Voices).....</b>	<b>18</b>
Selecting a Voice.....	18
Listening to the Demo Songs .....	19
Adding Variations to the Sound (Reverb) .....	20
Transposing the Pitch in Semitones .....	21
Fine-tuning the Pitch .....	21
Layering Two Voices (Dual mode) .....	22
Playing Duo.....	23
<b>Song Playback and Practice .....</b>	<b>24</b>
Listening to 50 Preset Songs.....	24
Listening to Songs Loaded from the Computer ...	24
Practicing a One-Hand Part.....	25
Playing Back Immediately from the First Note (Quick Play) .....	25

<b>Recording Your Performance .....</b>	<b>26</b>
Recording Your Performance .....	26
Changing the Initial Settings of the Recorded Song .....	27
Deleting Recorded Data .....	27

<b>Using with a Computer or a Smart Device .....</b>	<b>28</b>
Using an App on Your Smart Device.....	28
Playback/Recording of Audio Data (USB Audio Interface) .....	28

<b>Backing up Data and Initializing the Settings .....</b>	<b>29</b>
Data Maintained When Power is Turned Off.....	29
Saving User Song data to a computer .....	29
Initializing the Settings.....	29
Confirming the firmware version of this instrument.....	29

## Appendix

---

<b>Troubleshooting .....</b>	<b>30</b>
<b>Glossary of Terms .....</b>	<b>30</b>
<b>Keyboard Stand Assembly .....</b>	<b>31</b>
<b>Specifications .....</b>	<b>34</b>
<b>Index.....</b>	<b>35</b>



Thank you for purchasing this Yamaha Digital Piano!  
This instrument provides exceptionally high-quality sound  
and expressive control for your playing enjoyment.

We recommend that you read this manual carefully so that you can fully take advantage of the advanced and convenient functions of the instrument. We also recommend that you keep this manual in a safe and handy place for future reference.

## About the Manuals

This instrument has the following manuals.

### ■ Included Manuals



#### **Owner's Manual (this book)**

Explains how to use the instrument.



#### **Quick Operation Guide (separate sheet)**

Shows in chart form the functions assigned to the buttons and the keyboard for quick understanding.

### ■ Online Manuals (PDF)



#### **Smart Device Connection Manual**

Explains how to connect the instrument to a smart device such as smartphone or tablet, etc.



#### **Computer-related Operations**

Includes instructions on connecting this instrument to a computer, and operations related to transferring Song data.



#### **MIDI Reference**

Contains the MIDI Data Format and MIDI Implementation chart, as well as descriptions on MIDI functions such as MIDI channel and Local Control settings.

To obtain these materials, access the Yamaha Downloads website, then enter the model name for searching the desired files.

#### **Yamaha Downloads**

<https://download.yamaha.com/>

#### **NOTE**

For a general overview of MIDI and how you can effectively use it, search for "MIDI Basics" (only in English, German, French and Spanish) on the website above.

## Included Accessories

- Owner's Manual (this book) x1
- Quick Operation Guide (separate sheet) x1
- "50 Classical Music Masterpieces" (music book) x1
- Online Member Product Registration x1
- Warranty\* x1
- AC adaptor\* x1
- Power cord\* x1
- Bench\* x1

\* May not be included depending on your particular area. Please check with your Yamaha dealer.

### **Smart device app "Smart Pianist"**

With the specially developed "Smart Pianist" app running on your smart device, you can remotely control your digital piano for even more convenience and flexibility. By presenting various parameters on-screen, this app allows you to make settings in a visual, more intuitive manner. For more details on "Smart Pianist," refer to the following Yamaha website.

<https://www.yamaha.com/kbdapps/>

The connection wizard of the "Smart Pianist" helps you to connect this instrument to your smart device properly. To start the Connection Wizard, tap "☰" (Menu) located at the upper left of the screen to open the Menu display, and then tap "Instrument" → "Start Connection Wizard."

# Panel Controls and Terminals

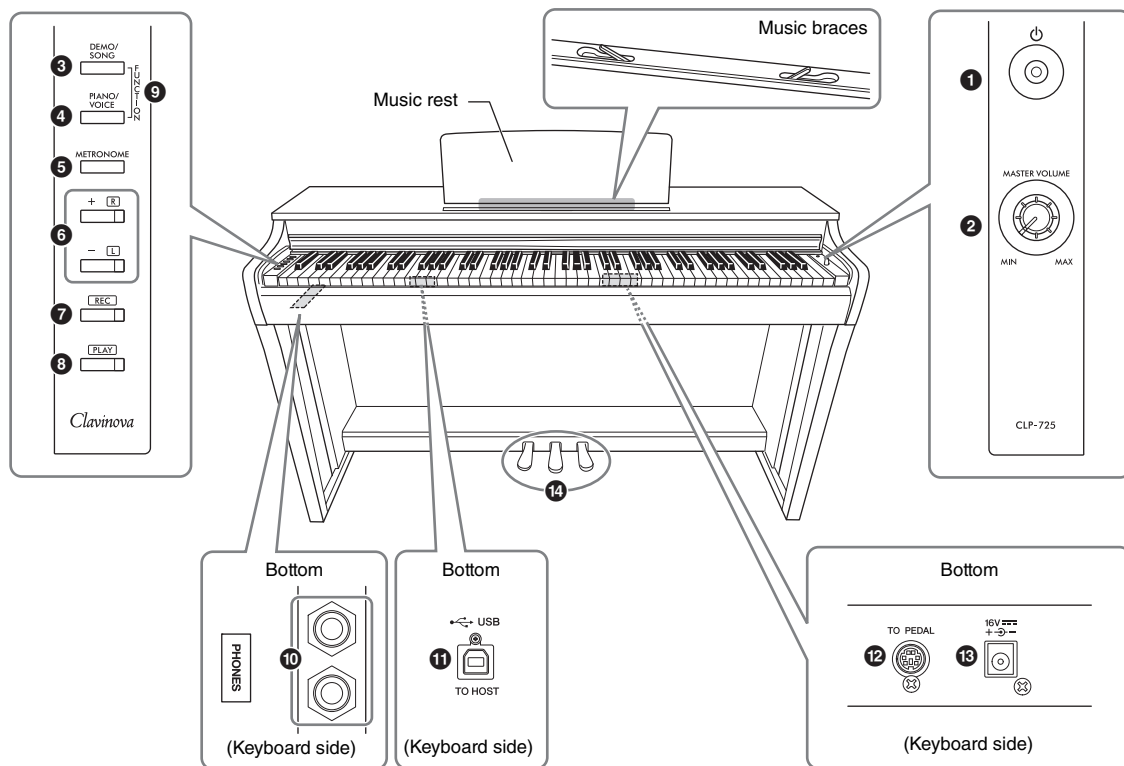

- 1** [⏻] (Standby/On) switch..... **page 12**  
For turning the power on or setting to standby.
- 2** [MASTER VOLUME] knob  
For adjusting the volume of the entire sound.
- 3** [DEMO/SONG] button..... **pages 19, 24**  
For playing the Demo Songs and the Preset Songs.
- 4** [PIANO/VOICE] button..... **pages 18, 20, 22**  
For selecting a single Voice, two Voices for layering or a Reverb Type.
- 5** [METRONOME] button ..... **page 17**  
For starting or stopping the metronome.
- 6** [+R], [-L] buttons ..... **pages 17, 18, 24, 25**
  - In general, these are for selecting the next or previous Voice.
  - During Song playback, these are for selecting the next or previous Song, and (while holding down [PLAY]) turning on/off the right-hand and left-hand Parts individually.
  - During Metronome playback, these are for increasing or decreasing the Tempo.
- 7** [REC] button..... **page 26**  
For recording your keyboard performance.
- 8** [PLAY] button..... **page 26**  
For playing back the recorded performance.
- 9** [FUNCTION] ..... **pages 12, 21**  
Simultaneously holding both [DEMO/SONG] and [PIANO/VOICE] and pressing a specified key allows you to change various settings, including Auto Power off function, Transpose parameters, etc.
- 10** [PHONES] jacks..... **page 13**  
For connecting a set of standard stereo headphones.
- 11** [USB TO HOST] terminal ..... **page 28**  
For connecting to a computer or a smart device such as an iPhone or iPad.
- 12** [TO PEDAL] jack ..... **page 32**  
For connecting the pedal cord.
- 13** DC IN jack..... **page 12**  
For connecting the AC adaptor.
- 14** Pedals ..... **page 14**  
For controlling expression and sustain, just as on an acoustic piano.

## Setting Up

### Key Cover

#### To open the key cover:

Lift the cover slightly, then push and slide it to the end.

#### To close the key cover:

Slide the cover toward you and gently lower the cover over the keys.

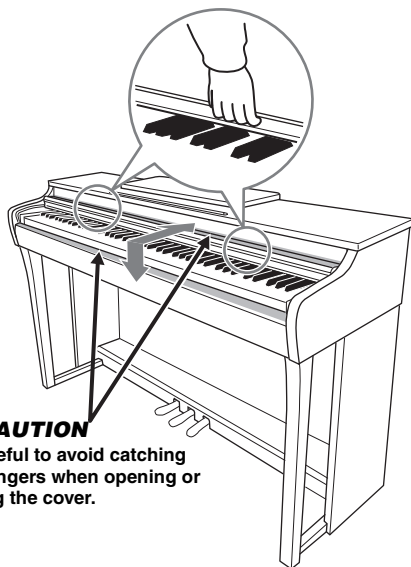

**CAUTION**  
Be careful to avoid catching your fingers when opening or closing the cover.

#### **CAUTION**

- Hold the cover with both hands when opening or closing it. Do not release it until it is fully opened or closed. Be careful to avoid catching fingers (yours or others, especially children's) between the cover and main unit.
- Do not place objects, such as a piece of metal or paper, on top of the key cover. Small objects placed on the key cover may fall inside the unit when the cover is opened and may be nearly impossible to remove. This could cause electric shock, short circuit, fire or other serious damage to the instrument.

### Music Rest

#### To raise the music rest:

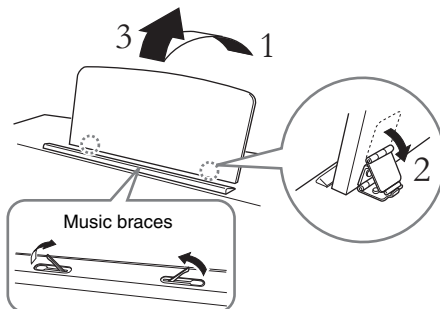

Music braces allow you to hold the pages of music books in place.

#### **CAUTION**

Do not try to use the music rest in a half-raised position. When lowering the music rest, do not release your hands from the music rest until it is all the way down.

#### To lower the music rest:

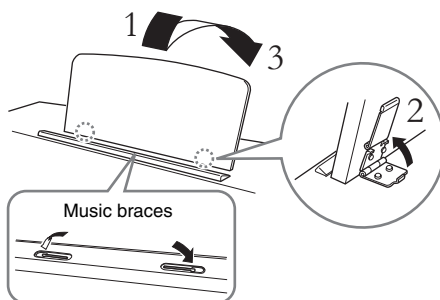

Close the Music braces if they are open, and then lower the music rest by following the instructions below.

## Turning the Power On

1. Connect the plugs of the AC adaptor in the order shown in the illustration.

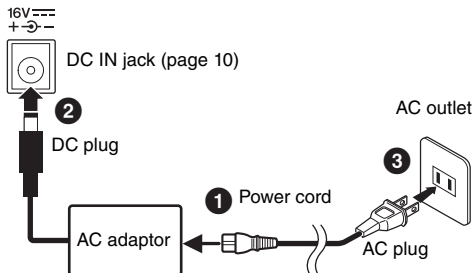

The shape of the plug and outlet differ depending on the locale.

### WARNING

Use the specified adaptor (page 34) only. The use of other adaptors may result in irreparable damage to both the adaptor and the instrument.

### CAUTION

When setting up the product, make sure that the AC outlet you are using is easily accessible. If some trouble or malfunction occurs, immediately turn off the power switch and disconnect the plug from the outlet.

### NOTE

Follow this procedure in reverse order when disconnecting the AC adaptor.

2. Turn down the [MASTER VOLUME] knob to “MIN.”

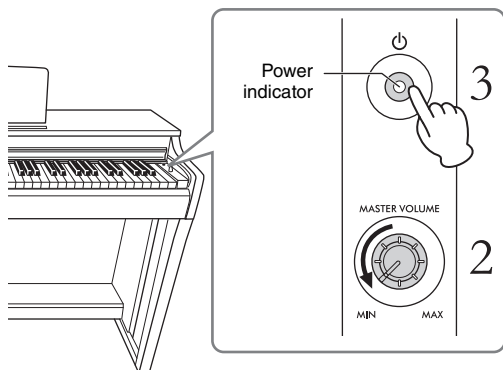

3. Press the [⏻] (Standby/On) switch to turn the power on.

The power indicator on the button lights up to indicate the power is on.

To adjust the volume of the entire keyboard sound, use the [MASTER VOLUME] dial while playing the keyboard.

When you're ready to turn the power to standby, press the [⏻] (Standby/On) switch again for a second. The power indicator turns off.

### CAUTION

Even when the [⏻] (Standby/On) switch is in the standby status, electricity is still flowing to the instrument at a minimum level. When not using the instrument for an extended period of time, be sure to unplug the power cord from the wall AC outlet.

### CAUTION

Do not use this instrument at a high volume level for a long period of time, to avoid damaging your hearing.

### NOTICE

Press only the [⏻] (Standby/On) switch when turning the power on. Any other operations, such as pressing the keys, buttons or pedals may cause the instrument to malfunction.

## Auto Power Off Function

To prevent unnecessary power consumption, this instrument features an Auto Power Off function that automatically turns the power off if the instrument is not operated for approximately 30 minutes.

**Default setting:** Enabled

While holding down [DEMO/SONG] and [PIANO/VOICE] simultaneously, press the A#0 key to enable the function or the A0 key to disable it.



You can also disable the function when turning on the power to the instrument.

While holding down the A-1 key (the lowest key, press the [⏻] (Standby/On) switch to turn the instrument on. The [REC] indicator flashes three times, indicating the Auto Power Off function has been disabled.

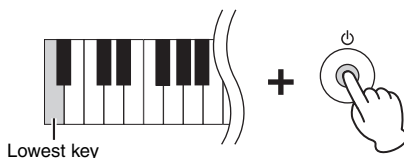

## Using Headphones

Since this instrument is equipped with two [PHONES] jacks, you can connect two sets of standard stereo headphones. If you are using only one set of headphones, insert a plug into either jack, which automatically shuts off the speakers according to the default setting.

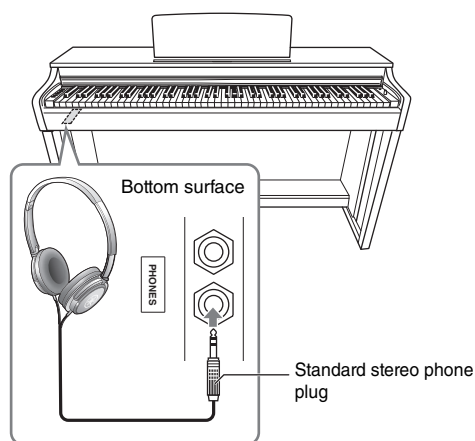

### ⚠ CAUTION

Do not use headphones at a high volume for an extended period of time; doing so may cause hearing loss.

## Using the headphone hanger

You can hang the headphones on this instrument. For instructions on installing the headphone hanger, refer to “Keyboard Stand Assembly” on page 31.

### NOTICE

Do not hang anything other than the headphones on the hanger. Doing so may damage this instrument or the hanger.

## Speaker On/Off setting

You can set whether the sound of this instrument is always output from its built-in speaker or not. While holding down [DEMO/SONG] and [PIANO/VOICE] simultaneously, press one of the D6 – E6 key.

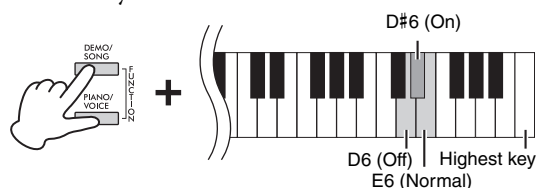

- **Off (D6):** The speaker will not sound.
- **On (D#6):** The speaker will always sound regardless of whether a set of headphones is connected or not.
- **Normal (E6):** The speaker will sound only if headphones are not connected. (This is the default setting.)

### NOTE

When this is set to “On,” Binaural Sampling and Stereophonic Optimizer below are not effective.

## Reproducing the Natural Sensation of Sound Distance—Binaural Sampling and Stereophonic Optimizer

This instrument features two advanced technologies that allow you to enjoy exceptionally realistic, natural sound, even when listening on headphones.

### Binaural Sampling (“CFX Grand” Voice only)

Binaural Sampling is a method that uses two special microphones set at the ear position of a performer and records the sound from a piano as it would actually be heard. Listening to the sound with this effect through headphones gives the impression of being immersed in the sound, as if it was actually emanating from the piano. Moreover, you can enjoy the sound naturally for a long time without ear fatigue. When the default Voice “CFX Grand” (page 18) is selected, connecting the headphones automatically enables the binaural sampling sound.

### Stereophonic Optimizer (Piano Voices other than “CFX Grand”)

Stereophonic Optimizer is an effect which reproduces the natural sound distance, like with the sound of Binaural Sampling, even though you are listening to it on headphones. When a piano Voice other than “CFX Grand” is selected, connecting the headphones automatically enables the Stereophonic Optimizer.

**Default setting:** On

While holding down [PIANO/VOICE], press the F#3 key to turn the function on or the F3 key to turn the function off.

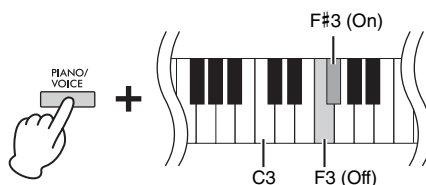

# Playing the Piano

## Using the Pedals

### Damper Pedal (Right)

Pressing this pedal will sustain notes longer. Releasing this pedal immediately stops (damps) any sustained notes. This pedal also features a “half-pedal” function that creates partial sustain effects, depending on how far down you press the pedal.

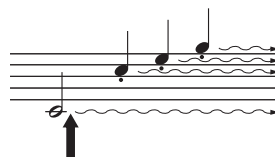

When you press the damper pedal here, this note and the notes you play before you release the pedal sustain longer.

### Sostenuto Pedal (Center)

Pressing this pedal while holding the notes will sustain the pressed notes (as if the Damper Pedal had been pressed), but all subsequently played notes will not be sustained. This makes it possible to sustain a chord or single low note, for example, while the other notes are played “staccato.”

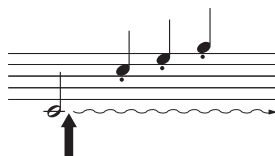

When you press the sostenuto pedal here while holding the note, the note will sustain as long as you hold the pedal.

### Soft Pedal (Left)

Pressing this pedal will reduce the volume and slightly change the timbre of the notes. The notes played before this pedal is pressed are not affected.

#### NOTE

If the damper pedal doesn't work, make sure that the pedal cord is properly plugged into the main unit (page 32).

#### Half-pedal function

This function allows you to vary the sustain length depending on how far the pedal is pressed. The farther down you press the pedal, the more the sound sustains. For example, if you press the damper pedal and all notes you are playing sound a bit murky and loud with too much sustain, you can release the pedal half way or higher to decrease the sustain (murkiness).

#### NOTE

While the sostenuto pedal is held, the organ and strings Voices sound continuously without decay after the notes have been released.

#### NOTE

When Jazz Organ Voice (page 18) is selected, pressing the left pedal switches between fast/slow rotation of the rotary speaker. When the Vibraphone Voice (page 18) is selected, the left pedal switches Vibrato on and off.

## Turning the VRM Effect On/Off

VRM (Virtual Resonance Modeling) technology accurately recreates the unique resonance of an acoustic grand piano's soundboard and strings. When you select a piano Voice (page 18), pressing the damper pedal activates the VRM effect. For details on VRM, see page 30.

While holding down [PIANO/VOICE], press the C#3 key to turn the function on or the C3 key to turn the function off.

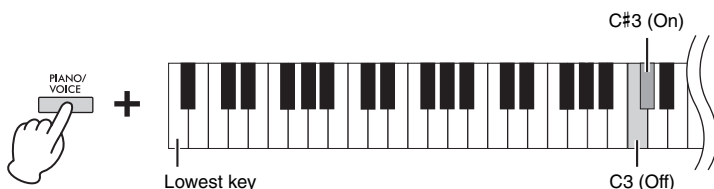

#### Default setting:

On

## Intelligent Acoustic Control (IAC)

With this function, the sound quality of this instrument is automatically adjusted and controlled according to the overall volume. Even when the volume is low, this lets you hear both low sounds and high sounds clearly.

### To turn on/off IAC:

While holding down [DEMO/SONG] and [PIANO/VOICE] simultaneously, press the C#2 key to turn the function on or the C2 key to turn the function off.

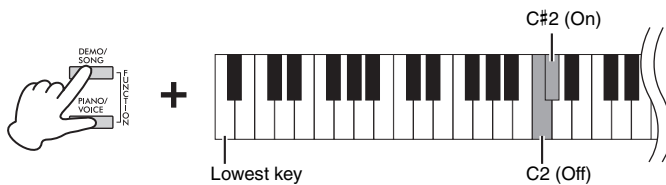

**Default setting:**  
On

### To adjust IAC Depth:

While holding down [DEMO/SONG] and [PIANO/VOICE] simultaneously, press the D2 key to decrease the value, or the E2 key to increase.

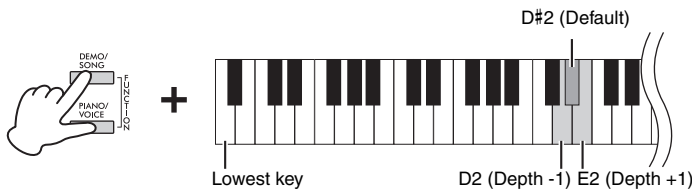

**Setting range:**  
-3 – +3

**Default setting:**  
0 (D#2)

The higher the value, the more clearly that low and high sounds are heard at lower volume levels.

## Grand Expression Modeling

When a piano Voice (page 18) is selected, you can add Grand Expression Modeling effects, which simulate the physical sound transitions of an actual piano. When this feature is set to “Dynamic,” you can control extremely subtle nuances in the performance and sound by changing your playing strength or touch. When set to “Static,” the nuances are generally fixed. For details on Grand Expression Modeling, see page 30.

While holding down [PIANO/VOICE], press the A#3 key to turn the function on or the A3 key to turn the function off.

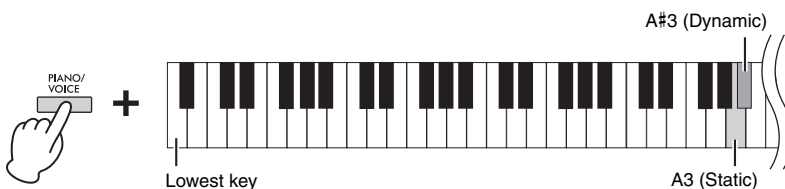

**Default setting:**  
Dynamic

## Turning the Operation Confirmation Sounds On/Off

When a setup is changed using a button and key combination, an operation sound (on, off, click, tempo value input) is sounded. This confirmation sound can be enabled (on) or disabled (off) as desired.

While holding down [DEMO/SONG] and [PIANO/VOICE] simultaneously, press the A#-1 key to turn the sounds on or the A-1 key to turn the sounds off.

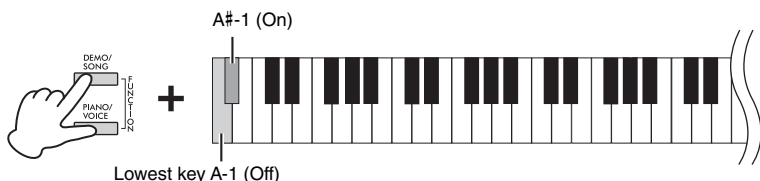

**Default setting:**  
On

## Changing the Touch Sensitivity

You can specify the Touch Sensitivity (how the sound responds to the way you play the keys).

While holding down [PIANO/VOICE], press one of the C6 – D#6 keys.

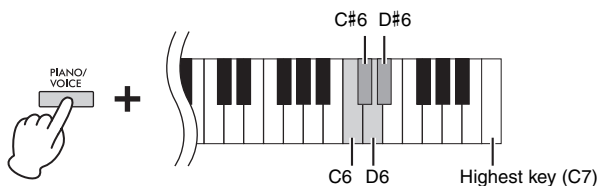

**NOTE**  
This setting is disabled with some Voices, such as an organ sound.

**Default setting:**  
Medium (C#6)

Key	Touch Sensitivity	Description
C6	Soft	Produces relatively high volume even with light playing strength.
C#6	Medium	Standard Touch Sensitivity.
D6	Hard	Requires strong playing to produce high volume.
D#6	Fixed	The volume level does not change at all regardless of whether you play the keyboard soft or hard.



## Using the Metronome

The metronome feature is convenient for practicing with an accurate tempo. To start or stop the Metronome, press [METRONOME].

### Metronome setting

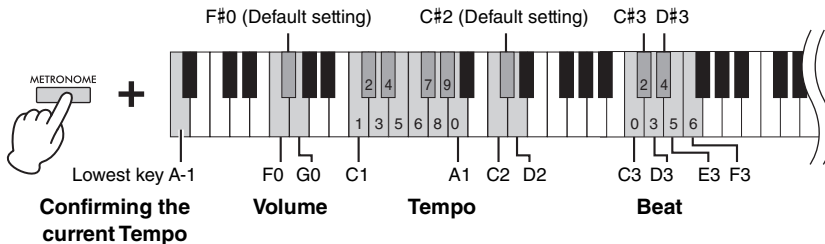

### Voice confirmation of current Tempo value (in English)

While holding down [METRONOME], press the A-1 key (lowest key).

### Selecting the Beat (time signature)

While holding down [METRONOME], press one of the C3 – F3 keys.

The first beat is accented with a bell sound and the rest with clicks. Default set is 0 (C3). In this setting, clicks sound in all beats.

### Adjusting the Tempo

The Metronome tempo can be set from 5 to 280 beats per minute.

- **To increase or decrease the value by 1:**

While holding down [METRONOME], press [+R] to increase or [-L] to decrease. While the metronome is playing, press [+R] to increase or [-L] to decrease.

- **To increase or decrease the value by 10:**

While holding down [METRONOME], press the D2 key to increase or the C2 key to decrease.

- **To specify a numeric value:**

While holding down [METRONOME], press the relevant C1 – A1 keys one by one in order, and then release [METRONOME] to enter the value.

- **Resetting the value to the default (120)**

While holding down [METRONOME], press [+R] and [-L] simultaneously, or press the C#2 key. While the metronome is playing, press [+R] and [-L] simultaneously.

### Adjusting the Volume

While holding down [METRONOME], press the G0 key to increase the volume or the F0 key to decrease. To reset to the default setting, press the F#0 key while holding down [METRONOME].

Key	Beat
C3	0 (no accent)
C#3	2
D3	3
D#3	4
E3	5
F3	6

#### NOTE

A numeric value is read out when a relevant key is pressed. If the entered value is outside the setting range, it will be ignored.

#### Setting range:

1 – 10

#### Default setting:

7 (F#0)

## Playing Various Musical Instrument Sounds (Voices)

### Selecting a Voice

#### To select “CFX Grand”:

Simply press [PIANO/VOICE].

#### To select another Voice:

After pressing [PIANO/VOICE], press [+R] or [-L] to select the next or previous Voice.

#### To select a specific Voice:

While holding down [PIANO/VOICE], press one of the C1 – A1 keys. For details on which Voice is assigned to each key, see the list below.

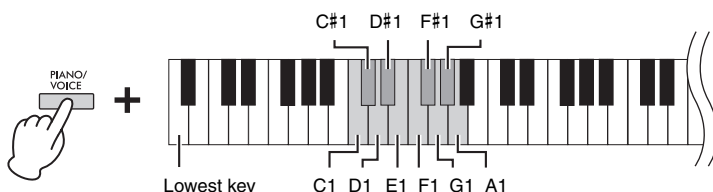

#### NOTE

To hear the characteristics of the Voices, play back the Demo Songs (page 19).

### Voice List

Key	Voice Name	Voice description
C1	CFX Grand	Yamaha's CFX flagship concert grand piano sound with a wide dynamic range for maximum expressive control. Suitable for playing in any music genre and style.
	Binaural CFX Grand	Yamaha's CFX flagship concert grand piano sound sampled by Binaural Sampling, the method optimized for headphone use. Listening this through headphones gives the impression of being immersed in the sound, as if it was actually emanating from the piano. This Voice is selected automatically when headphones are connected.
C#1	Bösendorfer	The famed sound of the Vienna-made Bösendorfer full concert grand piano. Its spacious sound evokes the size of the instrument, and is ideal for expressing tenderness in compositions.
D1	Pop Grand	Bright piano sound. Good for clear expression and “cutting through” other instruments in an ensemble.
D#1	Stage E.Piano	The sound of an electric piano using hammer-struck metallic “tines.” Soft tone when played lightly, and an aggressive tone when played hard.
E1	DX E.Piano	An electronic piano sound created by FM synthesis. Good for standard popular music.
F1	Harpsichord	The definitive instrument for baroque music. Since harpsichord uses plucked strings, there is no touch response. There is, however, a characteristic additional sound when the keys are released.
F#1	Vibraphone	Vibraphone played with relatively soft mallets. The tone becomes more metallic the harder you play.
G1	Pipe Organ	This is a typical pipe organ sound (8 feet + 4 feet + 2 feet). Good for sacred music from the Baroque period.
G#1	Jazz Organ	The sound of a “tonewheel” type electric organ. Often heard in jazz and rock music.
A1	Strings	Stereo-sampled, large-scale strings ensemble with realistic reverb. Try combining this Voice with piano in the Dual mode.

## Listening to the Demo Songs

Special individual Demo Songs are provided for all of the instrument Voices.

### 1. Press [DEMO/SONG] to start playback.

The Demo Song for the current Voice starts. During playback, the [PLAY] lamp flashes at the current tempo. Starting with the selected song, the playback of the Demo Songs will continue. After the last demo song, the sequence then returns to the first Demo Song and repeats until you stop it.

#### To change the Demo Song during playback:

Press [+R] or [-L] to change to the next or previous Demo Song. To change to a specific Demo Song, simultaneously hold down [DEMO/SONG] and press one of the C1 – A1 keys.

#### NOTE

If you want to change the playback tempo, see page 17.

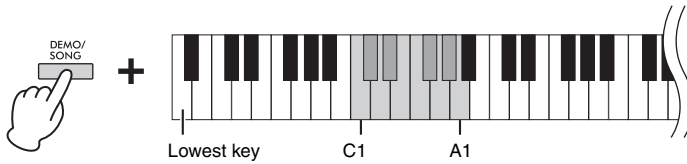

### 2. Press [DEMO/SONG] or [PLAY] to stop playback.

The [PLAY] lamp turns off.

### Demo Song List

Key	Voice Name	Title	Composer
C1	CFX Grand	Allegro de concierto Cis-Dur	E. Granados
	Binaural CFX Grand		
C#1	Bösendorfer	Widmung S.566 R.253	F. Liszt / R. Schumann
D1	Pop Grand	Original	—
D#1	Stage E.Piano	Original	—
E1	DX E.Piano	Original	—
F1	Harpsichord	Concerto a cembalo obbligato, 2 violini, viola e continuo No.7, BWV 1058	J. S. Bach
F#1	Vibraphone	Original	—
G1	Pipe Organ	Herr Christ, der ein'ge Gottes-Sohn, BWV 601	J. S. Bach
G#1	Jazz Organ	Original	—
A1	Strings	Original	—

The Demo Songs excluding original Songs are short rearranged excerpts from the original compositions. The original Demo Songs are Yamaha originals (© Yamaha Corporation).

## Adding Variations to the Sound (Reverb)

This instrument features several Reverb Types that add extra depth and expression to the sound to create a realistic acoustic ambience. The appropriate Reverb Type and Depth are called up automatically when you select each of the Voices and Songs. For this reason, the Reverb Type need not be selected; however, you can change it if desired.

### To select a Reverb Type:

While holding down [PIANO/VOICE], press one of the C2 – E2 keys.

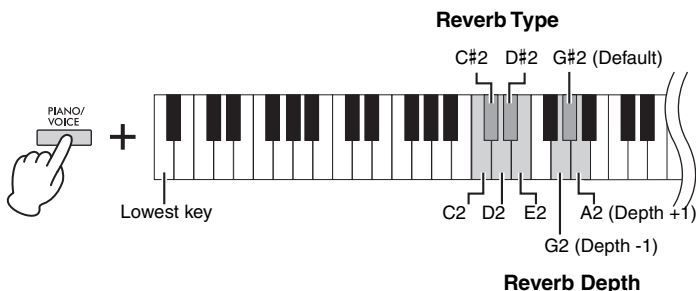

### Reverb in Dual Mode (page 22)

An optimum reverb type for the combination of Voices is assigned automatically.

### Reverb Type List

Key	Reverb Type	Description
C2	Recital Hall	Simulates the clear reverb sound you would hear in a medium-sized concert hall for piano recitals.
C#2	Concert Hall	Simulates the gorgeous reverb sound you would hear in a large concert hall for orchestral performances.
D2	Chamber	Suitable for playing chamber music; simulates the intimate reverb sound you would hear in a spacious room, such as for classical music recitals.
D#2	Club	Simulates the vivid reverb sound you would hear in a live music venue or a jazz club.
E2	Off	No effect is applied.

### To adjust Reverb Depth:

While holding down [PIANO/VOICE], press the G2 key to decrease the value by 1 or the A2 key to increase the value by 1.

While holding down [PIANO/VOICE], press the G#2 key to reset the Reverb Depth to the default setting, which is the most suitable value for the current Voice.

### Setting range:

0 (no effect) – 20 (maximum depth)

## Transposing the Pitch in Semitones

You can shift the pitch of the entire keyboard up or down in semitones in order to facilitate playing in difficult key signatures, or to easily match the pitch of the keyboard to the range of a singer or other instruments. For example, if “+5” is selected, playing key C produces pitch F, letting you play a song of F major as though it were in C major.

### To transpose the pitch down:

While holding down [DEMO/SONG] and [PIANO/VOICE], press a key between F#2 (-6) and B2 (-1).

### To transpose the pitch up:

While holding down [DEMO/SONG] and [PIANO/VOICE], press a key between C#3 (+1) and F#3 (+6).

### To restore the normal pitch:

While holding down [DEMO/SONG] and [PIANO/VOICE], press the C3 key.

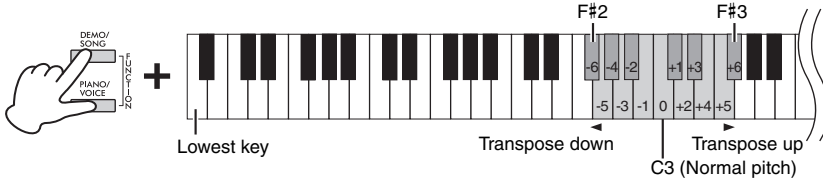

#### NOTE

The transposition setting affects not only the pitch of the keyboard but also the pitch of Song playback (page 24). The transposition setting of the Transposition for the Keyboard and the Song cannot be set independently.

#### Setting range:

-6 – 0 – +6

#### Default setting:

0

## Fine-tuning the Pitch

You can fine-tune the pitch of the entire instrument in about 0.2 Hz steps. This lets you accurately match the keyboard pitch to that of other instruments or CD music.

### To tune up (in about 0.2 Hz steps):

Press and hold down [DEMO/SONG] and [PIANO/VOICE] simultaneously, and press [+R].

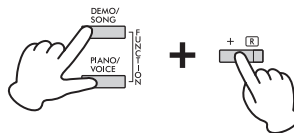

### To tune down (in about 0.2 Hz steps):

Press and hold down [DEMO/SONG] and [PIANO/VOICE] simultaneously, and press [-L].

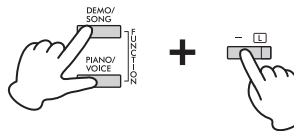

### To set the pitch to 442.0 Hz:

Press and hold down [DEMO/SONG] and [PIANO/VOICE] simultaneously, and press the C#1 key.



### To restore default pitch (440.0 Hz):

While simultaneously holding down [DEMO/SONG] and [PIANO/VOICE], press [+R] and [-L] simultaneously. Alternately, you can press the C1 key while holding down [DEMO/SONG] and [PIANO/VOICE] simultaneously.

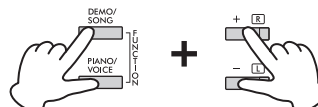

#### Hz (Hertz)

This unit of measurement refers to the frequency of a sound and represents the number of times a sound wave vibrates in a second.

#### Setting range:

414.8 – 466.8 Hz

#### Default setting:

A3 = 440.0 Hz

## Layering Two Voices (Dual mode)

You can layer two Voices and play them simultaneously to create a more richly textured sound.

### 1. Engage the Dual mode.

While holding down [PIANO/VOICE], simultaneously hold down two keys between C1 and A1 to select the two desired Voices. For information on which Voices are assigned to the keys, refer to “Voice List” (page 18).

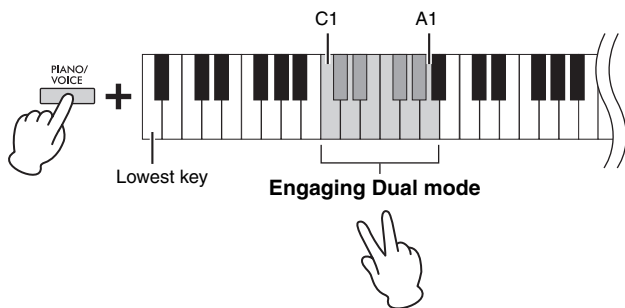

The Voice assigned to the lower key will be designated as Voice 1, and the Voice assigned to the higher key will be designated as Voice 2. You cannot assign the same Voice to both Voice 1 and Voice 2 simultaneously in Dual mode.

#### To shift the Octave for each Voice:

While holding down [PIANO/VOICE], press one of the keys F5 – G5 or A5 – B5 as shown in the illustration below. For example, pressing the B5 key twice while holding down [PIANO/VOICE] shifts Voice 1 up by two octaves. To restore the default setting, simultaneously hold down [PIANO/VOICE] and press the A#5 key for Voice 1 or the F#5 key for Voice 2.

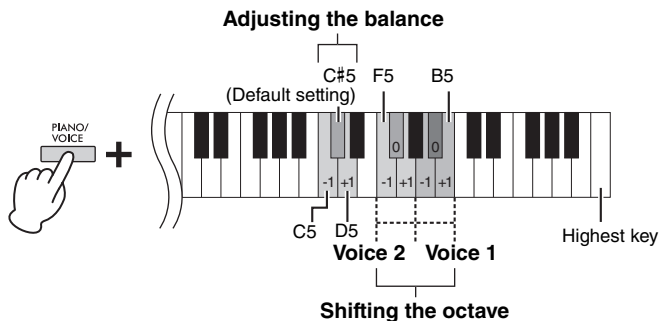

#### To adjust the Balance between two Voices:

While holding down [PIANO/VOICE], press the C5 key to decrease the value or the D5 key to increase. Pressing the C5 key increases the volume of Voice 2, while pressing the D5 key increases the volume of Voice 1. To reset to the default value for each combination of Voices, press the C#5 key.

### 2. To exit from Dual mode, press [PIANO/VOICE].

#### NOTE

The Dual and Duo modes (page 23) cannot be engaged at the same time.

#### Setting range:

-2 - 0 - +2

#### Setting range:

-6 - (default setting) - +6

#### Default setting:

Differs depending on the Voice combination.

## Playing Duo

This function allows two different players to play the instrument, one on the left and the other on the right, over the same octave range and with the same Voice.

### 1. While holding down [PIANO/VOICE], press [+R] and [-L] simultaneously to engage Duo.

The keyboard is divided into two sections, with the E3 key as the Split Point.

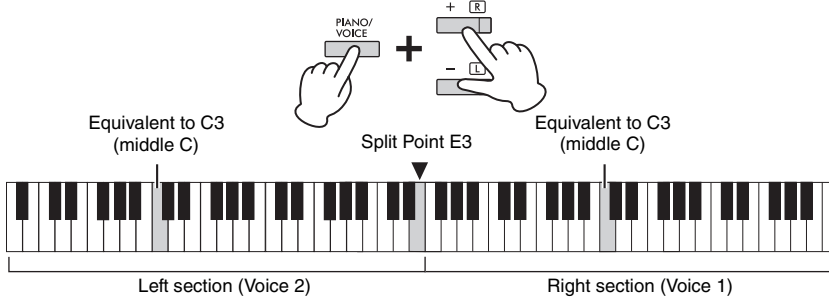

### 2. One person can play the left section of the keyboard while the other plays the right.

The pedal function changes as follows.

- **Right Pedal:** Applies Sustain to the right section.
- **Center Pedal:** Applies Sustain to both sections.
- **Left Pedal:** Applies Sustain to the left section.

**To shift the Octave for each section:**

Same operation as in Dual (page 22).

**To adjust the volume balance between two keyboard sections:**

Same operation as in Dual (page 22).

### 3. To exit from Duo, simultaneously hold down [PIANO/VOICE] and press [+R] and [-L].

## Selecting the Duo type

You can set how the sound is emitted from the speakers. When you select “Separated,” the sound of left part is emitted from the left speaker, and the sound of right section is emitted from the right speaker. When you select “Balanced,” the sound of both parts are emitted from both speakers in a natural balance.

While holding down [PIANO/VOICE], press the A4 key or the A#4 key to change the setting.

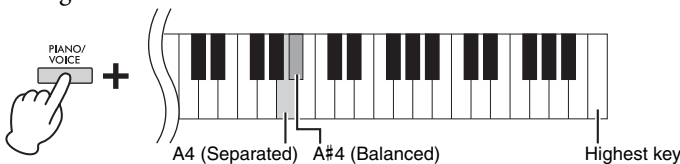

#### NOTE

- The Split Point cannot be changed from E3.
- In Duo, VRM is not effective.
- When the Duo type is set to “Separated,” Reverb and Binaural Sampling/ Stereophonic Optimizer are not effective.
- If the keyboard is in Dual mode, engaging Duo will exit from Dual, and Voice 1 is used over the entire range of the keyboard.

#### Setting range:

-2 - 0 - +2

#### Setting range:

-6 - 0 - +6

#### Default setting:

Separated

# Song Playback and Practice

## Listening to 50 Preset Songs

In addition to the Demo Songs, Preset Songs are provided for your listening pleasure.

1. Find the number of the Song that you want to play back from the included “50 Classical Music Masterpieces.”
2. While holding down [DEMO/SONG], press one of the C2 – C#6 keys to start playback.

The number of each piano Preset Song is assigned to the C2 – C#6 keys.

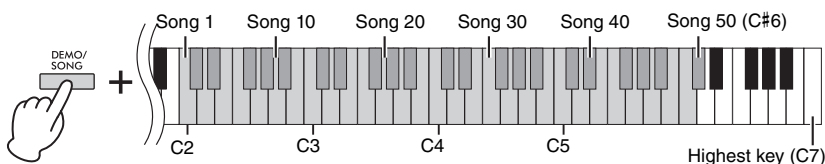

During playback, the [+R] and [-L] lamps light, and the [PLAY] lamp flashes at the current tempo. Playback of the Preset Songs continues in sequence, starting with the selected song. After the last Preset Song, the sequence then returns to the first Preset Song and repeats until you stop it.

### To change the Preset Song during playback:

Press [+R] or [-L] to change to the next or previous Preset Song, or directly select the desired Song by holding down [DEMO/SONG] and pressing the appropriate key.

### To change the tempo during playback:

While holding down [METRONOME], press [+R] or [-L] to increase or decrease the Tempo value by 1. Other instructions are the same as those of the Metronome Tempo (page 17).

### To play back from the beginning of the Song

During playback, press [+R] and [-L] simultaneously to jump to the playback position at the beginning of the Song then continue playback at the last specified tempo.

3. Press [DEMO/SONG] or [PLAY] to stop playback.

The [PLAY], [+R] and [-L] lamps turn off.

### Song:

In this manual, performance data is called a “Song.” This includes 50 Preset Songs and Demo Songs.

### NOTE

You can play the keyboard along with the Preset Song. You can also change the Voice played from the keyboard.

### NOTE

The Preset Songs, Demo Songs and other Songs (a maximum of ten) transferred from a computer can be played back consecutively within each category.

### NOTE

You can import additional Songs by loading SMF files from a computer. For details, refer to the “Computer-related Operations” on the website (page 9).

## Listening to Songs Loaded from the Computer

You can transfer up to 10 songs from your computer to this instrument and play them back. For details on transferring Songs from a computer and playing them back on this instrument, refer to the “Computer-related Operations” section on the website (page 9).

### Types of file that can be exchanged with a computer

Files with a .mid extension (SMF format 0 or 1)

### NOTE

Certain MIDI files in SMF format 0 or 1 may contain data that is not supported by your digital piano, and such files may not play as originally intended. If this is the case, setting the song playback channels to “1&2” may enable a better rendition of the song. For details, refer to the “Computer-related Operations” section on the website (page 9).



## Practicing a One-Hand Part

All the Songs except for the Demo (page 19) let you turn on or off the left-hand and right-hand Parts individually. By turning off [+R], for example, you can practice the right-hand Part while the left-hand Part is playing back, and vice versa.

1. **Start playback of a Preset Song (page 24) or the User Song (page 26).**
2. **While holding down [PLAY], press [+R] or [-L] to turn the Part on/off.**

Pressing the same button repeatedly while holding down [PLAY] toggles playback on and off. The lamp of the button lights to indicate that the corresponding Part is on.

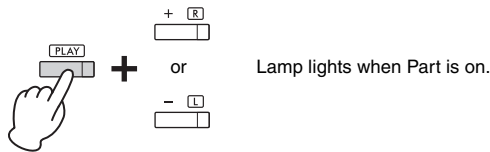

### NOTE

Selecting another Song will reset the on/off status.

### NOTE

Songs 16 – 20 of “50 Classical Music Masterpieces” are duet songs. The right-hand Part is for the first player, and the left-hand Part is for the second player.

3. **Practice the Part which is turned off.**

#### To change the Tempo:

While holding down [METRONOME], press [+R] or [-L] to increase or decrease the Tempo value by 1. Other instructions are the same as those of the Metronome Tempo (page 17).

4. **Press [PLAY] to stop playback.**

## Playing Back Immediately from the First Note (Quick Play)

This Quick Play feature enables you to specify whether a Song should play back immediately from the very first note, or play back any silence or rests that exist before the first note.

#### To turn on/off Quick Play:

While holding down [DEMO/SONG], press the A#-1 to turn the function on or A-1 key to turn the function off.

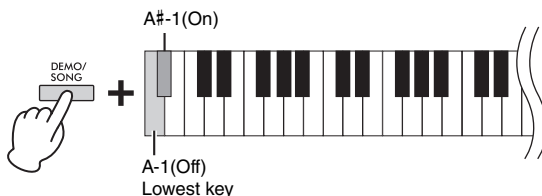

### Default setting:

On

# Recording Your Performance

Not only can you simply record your keyboard performance (Quick Recording), but you can record two parts (left-hand and right-hand) separately. The recorded data is called a User Song, and can be saved to a computer as a Standard MIDI file (SMF; page 29).

## Recording Your Performance

### 1. Select the desired Voice and other parameters, such as beat (time signature), for recording.

For instructions on selecting a Voice, refer to page 18. If necessary, set other parameters, such as beat (time signature) and effects, in this step.

### 2. Engage the Record Ready mode.

#### Quick Recording

Press [REC] to engage the Record Ready mode. Your keyboard performance will be automatically recorded to the right-hand part. Note that the already-recorded data of the right- and left-hand parts will be erased by Quick Recording.

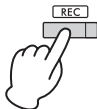

#### Recording to individual parts

While holding down [REC], press [+R] or [-L] to engage the Record Ready mode for the Part you want to record.

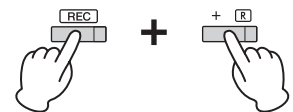

To record the right-hand Part ([+R])

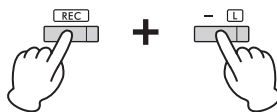

To record the left-hand Part ([-L])

If data has already been recorded to the other Part, the data in this Part will be played back while recording.

To turn the Part off or on, press the appropriate part button ([+R] or [-L]) while holding down [PLAY].

#### To exit from Record Ready mode:

Simply press [REC].

### 3. Play the keyboard or press [PLAY] to start recording.

The [REC] lamp lights up while the Recording Part lamp flashes at the current tempo.

### 4. Press either [REC] or [PLAY] to stop recording.

The [REC], [PLAY], [+R] and [-L] lamps flash, indicating that the recorded data is being stored. After the Save operation is completed, the lamps will turn off, indicating that the Record operation has been completed.

### 5. To hear the recorded Song, press [PLAY] to start playback.

Press [PLAY] again to stop playback.

#### To record to the other part

Repeat the steps above. In step 2, follow the instructions of “Recording individual parts.”

#### NOTE

The Recording function of this instrument will record your keyboard performance as MIDI data. If you want to record audio data, you can connect a computer to the instrument for that purpose. Refer to page 28 for details.

#### NOTE

You can use the Metronome while recording; however, the Metronome sound will not be recorded.

#### NOTE

If the keyboard is in the Duo mode (page 23), the data will be recorded to each Part. The Part for recording cannot be specified.

#### NOTICE

Note that recording your performance to a part containing data will replace already-recorded data with the new data.

#### NOTE

If the data capacity of the instrument approaches full when you engage Record Ready mode, the [REC] and [PLAY] lamps flash quickly for about three seconds.

#### NOTICE

Never turn off the power while the recorded data is being stored (while the lamps are flashing). Otherwise, all recorded data will be lost.

#### Recording Capacity

This instrument can record up to 250 KB (approximately 11,000 notes).

## Changing the Initial Settings of the Recorded Song

The settings of the following parameters can be changed after the Record operation is completed.

- For individual Parts: Voice, Volume balance (Dual/Duo), Reverb Depth
- For the entire Song: Tempo, Reverb Type

1. **Make settings for the above parameters as desired.**
2. **While holding down [REC], press the desired Part button to engage Record Ready mode.**

The [REC], [PLAY] and selected Part ([+R] or [-L]) lamps flash.

In this status, do not press [PLAY] again or any key. Otherwise, the originally recorded performance data will be deleted.

3. **While holding down [REC], press [PLAY] to exit from Record Ready mode.**

The [REC], [PLAY], [+R] and [-L] lamps flash. After the Save operation is completed, the lamps will turn off, indicating that the operation has been completed.

Confirm the setting by playing the Song.

## Deleting Recorded Data

### To delete the entire Song:

1. **While holding down [REC], press [DEMO/SONG].**

The [REC] and [PLAY] lamps flash alternately.

To exit from this status, press [REC].

2. **Press [PLAY] to delete the data of the entire Song.**

The [REC], [PLAY], [+R] and [-L] lamps flash.

After the operation is completed, all lamps turn off.

### To delete a specific Part:

1. **While holding down [REC], press [+R] or [-L] (depending on the Part you want to delete) to engage Record Ready mode.**

The [REC], [PLAY] and selected Part ([+R] or [-L]) lamps flash.

2. **Press [PLAY] to start recording without playing the keyboard.**

The selected Part ([+R] or [-L]) lamp flashes.

3. **Press [REC] or [PLAY] to stop recording.**

All data recorded for the selected Part will be deleted, and the lamp turns off.

#### NOTE

If a User Song has not been recorded to the instrument, the [REC] and [PLAY] lamps flash quickly for about three seconds.

# Using with a Computer or a Smart Device

By connecting a computer or a smart device to the [USB TO HOST] terminal via a USB cable, you can transmit/receive performance data and Song data to/from the computer or smart device.

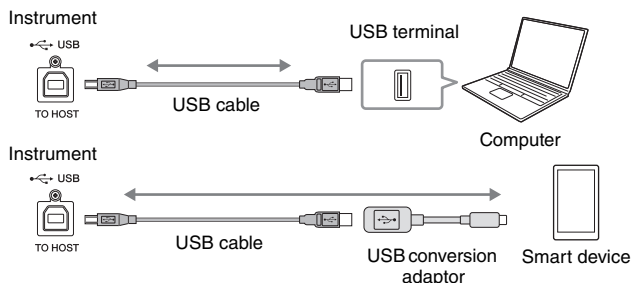

## NOTICE

- Use an AB type USB cable of less than 3 meters. USB 3.0 cables cannot be used.
- Do not place your smart device in an unstable position. Doing so may cause the device to fall and result in damage.

## NOTE

For instructions on using MIDI, refer to the online manual "MIDI Reference" (page 9).

For instructions on connection and transmitting/receiving MIDI data with a computer, refer to the "Computer-related Operations" on the website (page 9). For instructions on connection with a smart device, refer to the "Smart Device Connection Manual" on the website. If you use the smart device app "Smart Pianist" with the instrument, the connection wizard on the app helps you to connect the instrument to your smart device properly. For details, see page 9.

## Using an App on Your Smart Device

By using an app on a smart device, you can take advantage of convenient functions and get more enjoyment out of this instrument. In particular, with the "Smart Pianist" app running on your smart device, you can remotely control your digital piano for even more convenience and flexibility.

For information about the compatible smart devices and apps, access the following page:  
<https://www.yamaha.com/kbdapps/>

## Playback/Recording of Audio Data (USB Audio Interface)

You can play back audio data on a smart device or a computer with this instrument. You can also record your keyboard performance as audio data to a music production app on a smart device or a computer.

### Audio Loopback On/Off

You can set whether audio sound input from the [USB TO HOST] terminal is output to a computer or smart device or not, along with the performance played on the instrument (Audio Loopback function). To output the audio input sound, set Audio Loopback to "On."

While holding down [DEMO/SONG] and [PIANO/VOICE] simultaneously, press the G5 key to turn this parameter "Off" or the G#5 key to turn it "On."

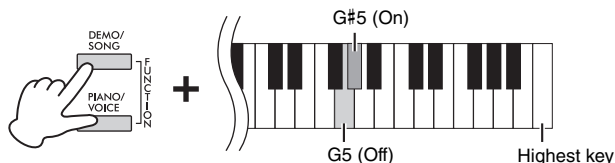

## NOTE

- The volume of the audio sound input can be adjusted from a computer or a smart device.
- When using this function on a computer running Windows, you will need to install the Yamaha Steinberg USB Driver to the computer. For details, refer to the "Computer-related Operations" on the website (page 9).

Default setting: On

## NOTICE

If you are using a DAW (digital audio workstation) with this instrument, set the Audio Loopback to OFF. Otherwise, loud noises may occur, depending on the settings of the computer/smart device or the application software.

# Backing up Data and Initializing the Settings

## Data Maintained When Power is Turned Off

The following settings and data are maintained even if you turn the power off.

- Metronome Volume
- Metronome Beat (time signature)
- Touch Sensitivity
- Tuning
- Intelligent Acoustic Control Depth
- Intelligent Acoustic Control On/Off
- Binaural Sampling/Stereophonic Optimizer On/Off
- Operation Confirmation Sounds On/Off
- Auto Power Off Enable/Disable
- Speaker On/Off
- Duo type Separated/Balanced
- User Song data
- Song data (SMF files) transferred from a computer

## Saving User Song data to a computer

Among the data listed above, only User Song data (USERSONG00.MID) can be transferred to a computer and saved as an SMF file. For details, refer to the “Computer-related Operations” on the website (page 9).

### NOTICE

Saved data may be lost due to malfunction or incorrect operation. Save important data to an external device such as a computer.

## Initializing the Settings

With this operation, all data (with the exception of the Songs) will be reset to the factory default settings.

To do this, simultaneously hold down the C7 (the highest) key and turn on the power.

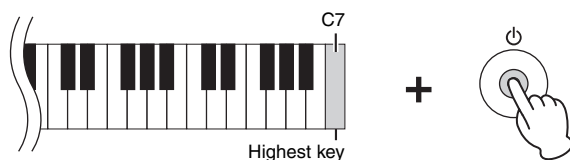

### NOTICE

Never turn off the power while the Initialize operation is being executed (that is, while the [REC], [PLAY], [+R] and [-L] lamps are flashing).

### NOTE

If this instrument somehow becomes disabled or malfunctions, turn off the power then execute Initialization.

## Confirming the firmware version of this instrument

You can confirm the firmware version of your instrument by audible voice in English.

While holding down [DEMO/SONG] and [PIANO/VOICE] simultaneously, press the B0 key.

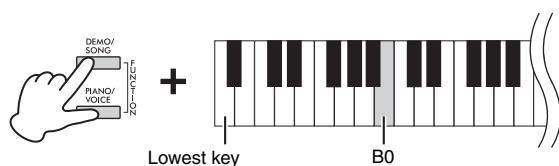

## About the latest Firmware Version

Yamaha may from time to time update firmware of the product without notice for improvement. Make sure to check our website for information of the latest release and upgrade the firmware for your instrument.

## Troubleshooting

Problem	Possible Cause and Solution
Power suddenly and unexpectedly turns off.	This is normal and the Auto Power Off function may have been activated (page 12). If desired, disable the Auto Power Off function.
The instrument does not turn on.	The plugs are not properly connected. Make sure that the DC plug is securely inserted into the DC IN jack on the instrument, and that the AC plug is securely inserted to the AC outlet (page 12).
A click or pop is heard when the power is turned on or off.	This is normal when electrical current is being applied to the instrument.
Noise is heard from the speakers or headphones.	The noise may be due to interference caused by the use of a mobile phone in close proximity to this instrument. Turn off the mobile phone, or move it further away from this instrument.
Metronome or Song goes out of tempo slightly when you play the keyboard.	This occurs infrequently when Grand Expression Modeling is set to "Dynamic." If this happens, set Grand Expression Modeling to "Static" (page 15).
The overall volume is low, or no sound is heard.	The Master Volume is set too low. Set it to an appropriate level using the [MASTER VOLUME] knob (page 10).
	Make sure a pair of headphones or conversion adaptor is not connected to the [PHONES] jack (page 13).
	The Speaker setting is "Off." Set the Speaker to "Normal" or "On" (page 13).
	Make sure that Local Control is On. For details, refer to the "MIDI Reference" (page 9).
Pedals do not function.	The pedal cord may not be securely connected to the [TO PEDAL] jack. Be sure to insert the pedal cord all the way until the metal part of the cord plug disappears from view (page 32).
The damper pedal does not function as expected.	The damper pedal was pressed when the power was turned on. This is not a malfunction; release the pedal and press it again to reset the function.

## Glossary of Terms

### VRM (Virtual Resonance Modeling)

On an actual acoustic piano, if you press the damper pedal and play a key, not only does the string of the pressed key vibrate, it also causes other strings and the soundboard to vibrate, with each influencing the rest, creating a rich and brilliant resonance that sustains and expands. The VRM technology featured in this instrument reproduces the complicated interaction between both string and soundboard resonance, and make the sound more like that of a real acoustic piano. Since resonance instantaneously occurs depending on the action of the keys and pedal, you can expressively vary the sound by changing the timing of your pressing the keys, and the timing and depth of your pressing the pedal.

### Grand Expression Modeling

On an actual acoustic piano, subtle changes in the sound can be produced by changing your playing touch from when you press a key to when you release it. For example, when you press a key all the way to its bottom, the key hits the keybed underneath and the noise reaches the strings, changing the sound slightly. Furthermore, the tone when the damper is lowered onto strings to mute the sound is changed by how quickly you release the key. The Grand Expression Modeling technology recreates these subtle changes in the sound that respond to your touch. This allows you to add accents by playing strongly or add resonance by playing softly to produce superbly expressive sound. A crisp tone can be heard when playing staccato as well as a lingering sound produced when releasing the keys slowly.

# Keyboard Stand Assembly

## ⚠ CAUTION

- Assemble the unit on a hard and flat floor with ample space.
- Be careful not to confuse parts, and be sure to install all parts in the correct orientation. Please assemble the unit in accordance with the sequence given below.
- Assembly should be carried out by at least two persons.
- Be sure to use only the included screws of the specified sizes. Do not use any other screws. Use of incorrect screws can cause damage or malfunction of the product.
- Be sure to tighten all screws upon completing assembly of the unit.
- To disassemble the unit, reverse the assembly sequence given below.

Have a Phillips-head (+) screwdriver of the appropriate size ready.

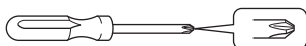

Remove all parts from the package and make sure you have all of the items.

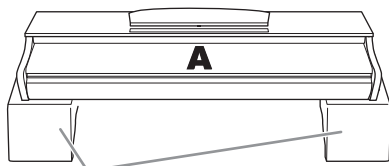

Foamed styrol pads

Remove foamed styrol pads from the package, position them on the floor, then place A on top of them. Position the pads so that they will not hide the connectors on the bottom of A.

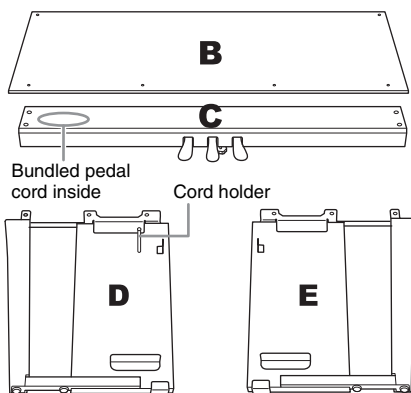

Bundled pedal cord inside

Cord holder

6 x 20 mm long screws x 4

4 x 12 mm thin screws x 2

4 x 20 mm tapping screws x 4

6 x 16 mm short screws x 6

4 x 10 mm thin screws x 2

Caps x 4

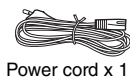

Power cord x 1

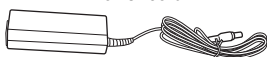

AC adaptor x 1

The power cord and adaptor may not be included, or may look different from the illustration above, depending on your particular area. Please check with your Yamaha dealer.



Headphone hanger x 1

1. Attach (finger-tighten) C to D and E.

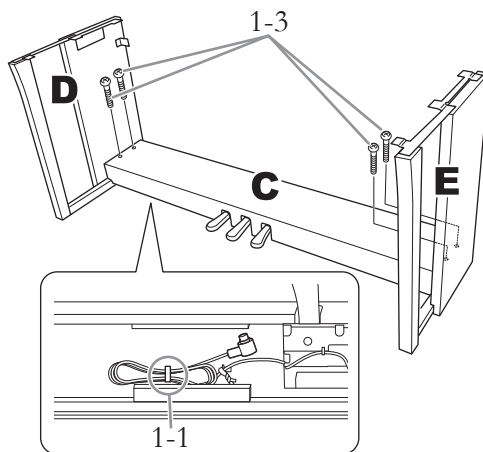

- 1-1 Untie and straighten out the bundled pedal cord.

- 1-2 Align D and E with each end of C.

- 1-3 Attach D and E to C by finger-tightening the long screws (6 x 20 mm).

2. Attach B.

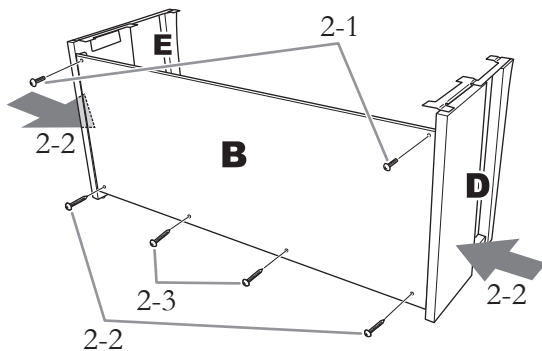

- 2-1 Align the screw holes on the upper side of B with the bracket holes on D and E, then attach the upper corners of B to D and E by finger-tightening two thin screws (4 x 12 mm).

- 2-2 While pushing the lower part of D and E from outside, secure the bottom ends of B using two tapping screws (4 x 20 mm).

2-3 Insert the other two tapping screws (4 x 20 mm) into the other two screw holes to secure B.

2-4 Securely tighten the screws on the top of B that were attached in Step 2-1.

3. Secure C.

3-1 Securely tighten the screws on C that were attached in Step 1-3.

3-2 Attach the caps to the head of the screws.

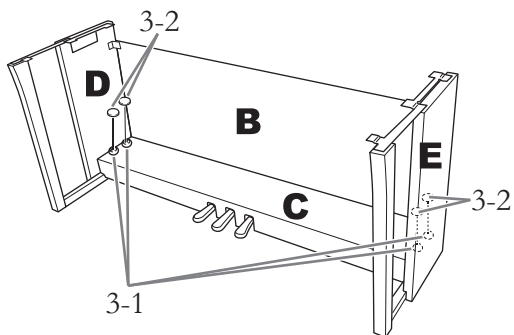

4. Mount A.

Be sure to place your hands at least 15 cm away from either end of the main unit when positioning it.

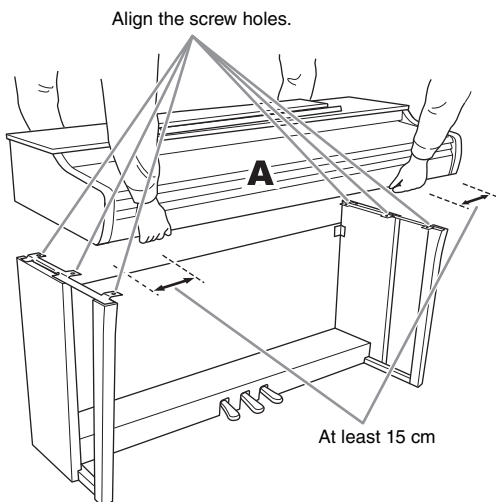

**CAUTION**

- Be extra careful not to drop the main unit or let your fingers be pinched by it.
- Do not hold the main unit in any position other than the position specified above.

5. Secure A.

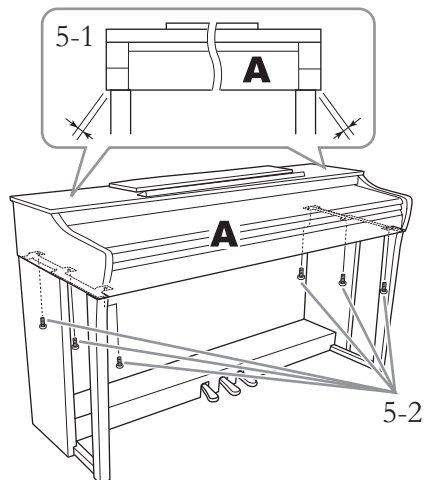

5-1 Adjust the position of A so that the left and right ends of A will project beyond D and E equally when seen from the front.

5-2 Secure A by tightening the short screws (6 x 16 mm) from the front.

6. Connect the pedal cord and the AC adaptor.

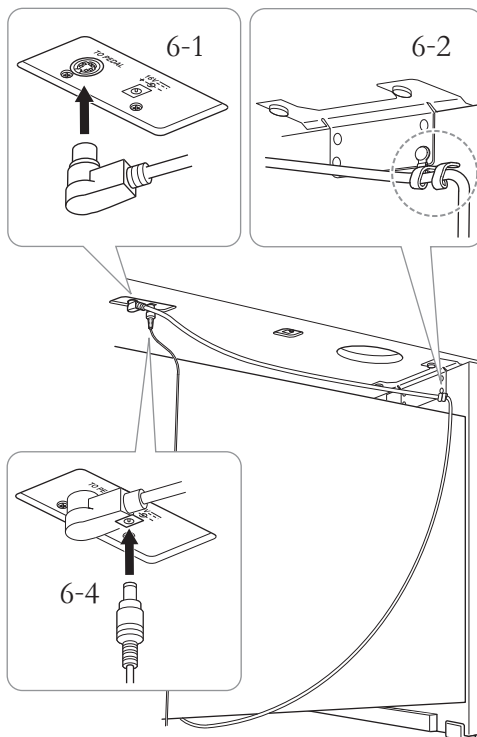



## 6-1 Insert the pedal cord plug to the pedal connector from the rear.

When connecting the pedal cord, insert the plug securely until the metal part disappears from view.

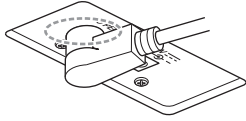

## 6-2 Securely wind the cord holder around the pedal cord.

The cord holder is attached to D.

## 6-3 Connect one end of the power cord to the AC adaptor.

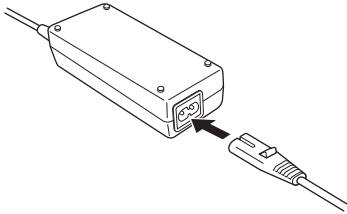

## 6-4 Insert the DC plug of the AC adaptor into the DC IN jack.

## 7. Set the adjuster.

Rotate the adjuster until it comes in firm contact with the floor surface.

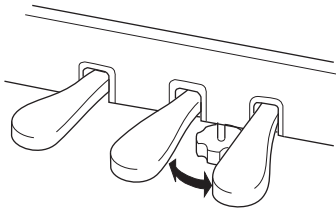

## 8. Attach the headphone hanger.

Use two thin screws (4 x 10 mm) to attach the hanger as shown in the illustration.

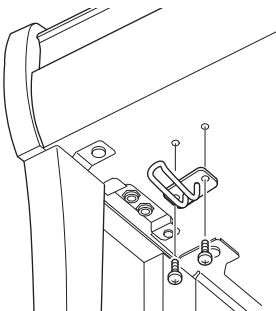

After completing the assembly, please check the following.

- **Are there any parts left over?**  
→ Review the assembly procedure and correct any errors.
- **Is this instrument clear of doors and other movable fixtures?**  
→ Move the instrument to an appropriate location.
- **Does this instrument make a rattling noise when you shake it?**  
→ Tighten all screws.
- **Does the pedal box rattle or give way when you step on the pedals?**  
→ Turn the adjuster so that it is set firmly against the floor.
- **Are the pedal cord plug and the adaptor plug inserted securely into the sockets?**  
→ Check the connection.

### **CAUTION**

When moving the instrument, always hold the bottom of the main unit. Do not hold the key cover or top portion. Improper handling can result in damage to the instrument or personal injury.

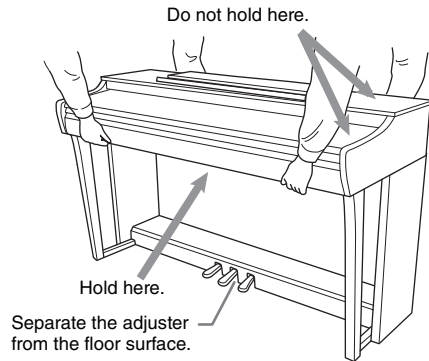

### Transporting

If you move to another location, you can transport the instrument along with other belongings. You can move the unit as it is (assembled), or you can disassemble the unit down to the condition it was in when you first took it out of the box. Transport the keyboard horizontally. Do not lean it up against a wall or stand it up on its side. Do not subject the instrument to excessive vibration or shock. When transporting the assembled instrument, make sure all screws are properly tightened and have not been loosened by moving the instrument.

### **CAUTION**

If the main unit creaks or is otherwise unsteady when you play on the keyboard, refer to the assembly diagrams and re-tighten all screws.

# Specifications

			CLP-725
Product Name			Digital Piano
Size/Weight	Width [For models with polished finish]		1,350 mm (53-1/8") [1,353 mm (53-1/4")]
	Height [For models with polished finish]	With music rest closed	849 mm (33-7/16") [851 mm (33-1/2")]
		With music rest raised	1,003 mm (39-1/2") [1,004 mm (39-1/2")]
	Depth [For models with polished finish]		414 mm (16-5/16") [415 mm (16-5/16")]
	Weight [For models with polished finish]		43 kg (94 lb, 13 oz) [45 kg (99 lb, 3 oz)]
Control Interface	Keyboard	Number of Keys	88
		Type	GrandTouch-S Keyboard: synthetic ebony and ivory key tops, escapement
		Touch Response	Hard/Medium/Soft/Fixed
	Pedal	Number of Pedals	3: Damper (with Half-pedal function), Sostenuto, Soft
	Panel	Language	English
Cabinet	Key Cover Style		Sliding
	Music Rest		Yes (with music braces)
Voices	Tone Generation	Piano Sound	Yamaha CFX, Bösendorfer Imperial
		Binaural Sampling	Yes (CFX Grand Voice only)
	Piano Effect	VRM	Yes
		Grand Expression Modeling	Yes
		Key-off Samples	Yes
		Smooth Release	Yes
	Polyphony (max.)		256
Preset	Number of Voices	10	
Effects	Types	Reverb	4 types
		Intelligent Acoustic Control (IAC)	Yes
		Stereophonic Optimizer	Yes
	Functions	Dual	Yes
		Duo	Yes
Recording/ Playback (MIDI data only; audio not supported.)	Preset	Number of Preset Songs	10 Voice Demo Songs, 50 Classics
	Recording	Number of Songs	1
		Number of Tracks	2
		Data Capacity	Approx. 250 KB/Song (approx. 11,000 notes)
	Format	Playback	SMF (Format 0, Format 1)
		Recording	SMF (Format 0)
Functions	Overall Controls	Metronome	Yes
		Tempo Range	5 – 280
		Transpose	-6 – 0 – +6
		Tuning	414.8 – 440.0 – 466.8 Hz (approx. 0.2 Hz increments)
		USB audio interface	Yes
Storage and Connectivity	Storage	Internal Memory	Total maximum size approx. 960 KB (User Song: One Song approx. 250 KB, Loading Song data from a computer: Up to 10 Songs)
		Connectivity	DC IN
	Headphones		Standard stereo phone jack (x 2)
	USB TO HOST		Yes
Sound System	Amplifiers		20 W x 2
	Speakers		12 cm x 2
Power Supply	AC Adaptor		PA-300C (or an equivalent recommended by Yamaha)
	Power Consumption		12 W (When using PA-300C AC adaptor)
	Auto Power Off		Yes
Included Accessories			Owner's Manual, Quick Operation Guide, 50 Classical Music Masterpieces (Music Book), Online Member Product Registration, Warranty*, AC adaptor* (PA-300C or an equivalent), Power cord*, Bench* * May not be included depending on your area. Check with your Yamaha dealer.
Separately Sold Accessories (May not be available depending on your area.)			Headphones (HPH-150/HPH-100/HPH-50), Wireless MIDI adaptor (UD-BT01), AC adaptor (PA-300C or an equivalent recommended by Yamaha)

\* The contents of this manual apply to the latest specifications as of the publishing date. To obtain the latest manual, access the Yamaha website then download the manual file. Since specifications, equipment or separately sold accessories may not be the same in every locale, please check with your Yamaha dealer.

# Index

## Numerics

50 Preset Songs .....24

## A

AC adaptor .....12

Accessories .....9

Audio Loopback .....28

Auto Power Off .....12

## B

Backing up Data .....29

Beat .....17

Binaural Sampling .....13

## C

Computer .....28

Computer-related Operations .....9

## D

Damper Pedal .....14

Delete .....27

Demo Song List .....19

Demo Songs .....19

Dual mode .....22

Duo .....23

## F

Firmware version .....29

## G

Grand Expression Modeling ..... 15, 30

## H

Half-pedal .....14

Headphones .....13

Hz (Hertz) .....21

## I

Initializing .....29

Intelligent Acoustic Control (IAC) .....15

## K

Key Cover .....11

## L

Left-hand Part .....25

## M

Manuals .....9

Metronome .....17

MIDI Reference .....9

Music Rest .....11

## O

Octave .....22

Operation Confirmation Sounds .....16

## P

Panel Controls and Terminals .....10

Pedals .....14

Pitch .....21

Playback .....24

Power .....12

Practice .....25

Preset Songs .....24

## Q

Quick Operation Guide .....9

Quick Play .....25

## R

Recording .....26

Reverb .....20

Reverb Depth .....20

Reverb Type .....20

Reverb Type List .....20

Right-hand Part .....25

## S

Smart Device .....28

Smart Device Connection Manual .....9

Smart Pianist .....9

Soft Pedal .....14

Song .....24

Sostenuto Pedal .....14

Speaker .....13

Stereophonic Optimizer .....13

## T

Tempo .....17

Time signature .....17

Touch Sensitivity .....16

Transpose .....21

Tuning .....21

## U

USB Audio Interface .....28

USB TO HOST .....10

## V

Voice .....18

Voice List .....18

Volume .....10, 17

VRM (Virtual Resonance Modeling) .....14, 30

### Information for users on collection and disposal of old equipment:



This symbol on the products, packaging, and/or accompanying documents means that used electrical and electronic products should not be mixed with general household waste.

For proper treatment, recovery and recycling of old products, please take them to applicable collection points, in accordance with your national legislation.

By disposing of these products correctly, you will help to save valuable resources and prevent any potential negative effects on human health and the environment which could otherwise arise from inappropriate waste handling.

For more information about collection and recycling of old products, please contact your local municipality, your waste disposal service or the point of sale where you purchased the items.

#### For business users in the European Union:

If you wish to discard electrical and electronic equipment, please contact your dealer or supplier for further information.

#### Information on Disposal in other Countries outside the European Union:

This symbol is only valid in the European Union. If you wish to discard these items, please contact your local authorities or dealer and ask for the correct method of disposal.

(weee\_eu\_en\_02)

### Informations concernant la collecte et le traitement des déchets d'équipements électriques et électroniques



Le symbole sur les produits, l'emballage et/ou les documents joints signifie que les produits électriques ou électroniques usagés ne doivent pas être mélangés avec les déchets domestiques habituels.

Pour un traitement, une récupération et un recyclage appropriés des déchets d'équipements électriques et électroniques, veuillez les déposer aux points de collecte prévus à cet effet, conformément à la réglementation nationale.

En vous débarrassant correctement des déchets d'équipements électriques et électroniques, vous contribuerez à la sauvegarde de précieuses ressources et à la prévention de potentiels effets négatifs sur la santé humaine qui pourraient advenir lors d'un traitement inapproprié des déchets.

Pour plus d'informations à propos de la collecte et du recyclage des déchets d'équipements électriques et électroniques, veuillez contacter votre municipalité, votre service de traitement des déchets ou le point de vente où vous avez acheté les produits.

#### Pour les professionnels dans l'Union européenne :

Si vous souhaitez vous débarrasser des déchets d'équipements électriques et électroniques, veuillez contacter votre vendeur ou fournisseur pour plus d'informations.

#### Informations sur la mise au rebut dans d'autres pays en dehors de l'Union européenne :

Ce symbole est seulement valable dans l'Union européenne. Si vous souhaitez vous débarrasser de déchets d'équipements électriques et électroniques, veuillez contacter les autorités locales ou votre fournisseur et demander la méthode de traitement appropriée.

(weee\_eu\_fr\_02)

## Apache License 2.0

Copyright (c) 2009-2018 Arm Limited. All rights reserved.

SPDX-License-Identifier: Apache-2.0

Licensed under the Apache License, Version 2.0 (the License); you may not use this file except in compliance with the License.

You may obtain a copy of the License at [www.apache.org/licenses/LICENSE-2.0](http://www.apache.org/licenses/LICENSE-2.0)

Unless required by applicable law or agreed to in writing, software distributed under the License is distributed on an AS IS BASIS, WITHOUT WARRANTIES OR CONDITIONS OF ANY KIND, either express or implied.

See the License for the specific language governing permissions and limitations under the License.

## Modified BSD license

COPYRIGHT(c) 2016 STMicroelectronics

Redistribution and use in source and binary forms, with or without modification, are permitted provided that the following conditions are met:

1. Redistributions of source code must retain the above copyright notice, this list of conditions and the following disclaimer.
2. Redistributions in binary form must reproduce the above copyright notice, this list of conditions and the following disclaimer in the documentation and/or other materials provided with the distribution.
3. Neither the name of STMicroelectronics nor the names of its contributors may be used to endorse or promote products derived from this software without specific prior written permission.

THIS SOFTWARE IS PROVIDED BY THE COPYRIGHT HOLDERS AND CONTRIBUTORS "AS IS" AND ANY EXPRESS OR IMPLIED WARRANTIES, INCLUDING, BUT NOT LIMITED TO, THE IMPLIED WARRANTIES OF MERCHANTABILITY AND FITNESS FOR A PARTICULAR PURPOSE ARE DISCLAIMED. IN NO EVENT SHALL THE COPYRIGHT HOLDER OR CONTRIBUTORS BE LIABLE FOR ANY DIRECT, INDIRECT, INCIDENTAL, SPECIAL, EXEMPLARY, OR CONSEQUENTIAL DAMAGES (INCLUDING, BUT NOT LIMITED TO, PROCUREMENT OF SUBSTITUTE GOODS OR SERVICES; LOSS OF USE, DATA, OR PROFITS; OR BUSINESS INTERRUPTION) HOWEVER CAUSED AND ON ANY THEORY OF LIABILITY, WHETHER IN CONTRACT, STRICT LIABILITY, OR TORT (INCLUDING NEGLIGENCE OR OTHERWISE) ARISING IN ANY WAY OUT OF THE USE OF THIS SOFTWARE, EVEN IF ADVISED OF THE POSSIBILITY OF SUCH DAMAGE.



**Important Notice:**  
**U.S. LIMITED WARRANTY for Customers in the United States**

For detailed information about this Yamaha product and warranty service, please either visit the following website address (printable file is available at our website) or contact Customer Service at the address or telephone number identified below.

**Website Address:**  
[Yamaha.io/ClavinovaWarranty](http://Yamaha.io/ClavinovaWarranty)

**Customer Service:**  
Yamaha Corporation of America  
6600 Orangethorpe Avenue, Buena Park, CA 90620-1273  
Telephone: 800-854-1569

# Important Notice: Guarantee Information for customers in European Economic Area (EEA) and Switzerland

<p><b>Important Notice: Guarantee Information for customers in EEA* and Switzerland</b></p> <p>For detailed guarantee information about this Yamaha product, and Pan-EEA* and Switzerland warranty service, please either visit the website address below (Printable file is available at our website) or contact the Yamaha representative office for your country. * EEA: European Economic Area</p>	English
<p><b>Wichtiger Hinweis: Garantie-Information für Kunden in der EWR* und der Schweiz</b></p> <p>Für nähere Garantie-Information über dieses Produkt von Yamaha, sowie über den Pan-EWR*- und Schweizer Garantieservice, besuchen Sie bitte entweder die folgend angegebene Internetadresse (eine druckfähige Version befindet sich auch auf unserer Webseite), oder wenden Sie sich an den für Ihr Land zuständigen Yamaha-Vertrieb. *EWR: Europäischer Wirtschaftsraum</p>	Deutsch
<p><b>Remarque importante: informations de garantie pour les clients de l'EEE et la Suisse</b></p> <p>Pour des informations plus détaillées sur la garantie de ce produit Yamaha et sur le service de garantie applicable dans l'ensemble de l'EEE ainsi qu'en Suisse, consultez notre site Web à l'adresse ci-dessous (le fichier imprimable est disponible sur notre site Web) ou contactez directement Yamaha dans votre pays de résidence. * EEE : Espace Economique Européen</p>	Français
<p><b>Belangrijke mededeling: Garantie-informatie voor klanten in de EER* en Zwitserland</b></p> <p>Voor gedetailleerde garantie-informatie over dit Yamaha-product en de garantieservice in heel de EER* en Zwitserland, gaat u naar de onderstaande website (u vindt een afdrukbaar bestand op onze website) of neemt u contact op met de vertegenwoordiging van Yamaha in uw land. * EER: Europese Economische Ruimte</p>	Nederlands
<p><b>Aviso importante: información sobre la garantía para los clientes del EEE* y Suiza</b></p> <p>Para una información detallada sobre este producto Yamaha y sobre el soporte de garantía en la zona EEE* y Suiza, visite la dirección web que se incluye más abajo (la versión del archivo para imprimir está disponible en nuestro sitio web) o póngase en contacto con el representante de Yamaha en su país. * EEE: Espacio Económico Europeo</p>	Español
<p><b>Avviso importante: informazioni sulla garanzia per i clienti residenti nell'EEA* e in Svizzera</b></p> <p>Per informazioni dettagliate sulla garanzia relativa a questo prodotto Yamaha e l'assistenza in garanzia nei paesi EEA* e in Svizzera, potete consultare il sito Web all'indirizzo riportato di seguito (è disponibile il file in formato stampabile) oppure contattare l'ufficio di rappresentanza locale della Yamaha. * EEA: Area Economica Europea</p>	Italiano
<p><b>Aviso importante: informações sobre as garantias para clientes da AEE* e da Suíça</b></p> <p>Para obter uma informação pormenorizada sobre este produto da Yamaha e sobre o serviço de garantia na AEE* e na Suíça, visite o site a seguir (o arquivo para impressão está disponível no nosso site) ou entre em contato com o escritório de representação da Yamaha no seu país. * AEE: Área Econômica Européia</p>	Português
<p><b>Σημαντική σημείωση: Πληροφορίες εγγύησης για τους πελάτες στον ΕΟΧ* και Ελλάδα</b></p> <p>Για λεπτομερείς πληροφορίες εγγύησης σχετικά με το παρόν προϊόν της Yamaha και την κάλυψη εγγύησης σε όλες τις χώρες του ΕΟΧ και την Ελλάδα, επισκεφτείτε την παρακάτω ιστοσελίδα (Εκτυπώσιμη μορφή είναι διαθέσιμη στην ιστοσελίδα μας) ή απευθυνθείτε στην αντιπροσωπεία της Yamaha στη χώρα σας. * ΕΟΧ: Ευρωπαϊκός Οικονομικός Χώρος</p>	Ελληνικά
<p><b>Viktigt: Garantiinformation för kunder i EES-området* och Schweiz</b></p> <p>För detaljerad information om denna Yamahaprodukt samt garantiservice i hela EES-området* och Schweiz kan du antingen besöka nedanstående webbadress (en utskriftsvänlig fil finns på webbplatsen) eller kontakta Yamahas officiella representant i ditt land. * EES: Europeiska Ekonomiska Samarbetsområdet</p>	Svenska
<p><b>Viktig merknad: Garantiinformasjon for kunder i EØS* og Sveits</b></p> <p>Detaljert garantiinformasjon om dette Yamaha-produktet og garantiservice for hele EØS-området* og Sveits kan fås enten ved å besøke nettstedene nedenfor (utskriftsversjon finnes på våre nettsider) eller kontakte Yamahas offisielle representant i landet der du bor. *EØS: Det europeiske økonomiske samarbeidsområdet</p>	Norsk
<p><b>Vigtig oplysning: Garantioplysninger til kunder i EØO* og Schweiz</b></p> <p>De kan finde detaljerede garantioplysninger om dette Yamaha-produkt og den fælles garantiserviceordning for EØO* (og Schweiz) ved at besøge det websted, der er angivet nedenfor (der findes en fil, som kan udskrives, på vores websted), eller ved at kontakte Yamahas nationale repræsentationskontor i det land, hvor De bor. * EØO: Det Europæiske Økonomiske Område</p>	Dansk
<p><b>Tärkeä ilmoitus: Takuutiedot Euroopan talousalueen (ETA)* ja Sveitsin asiakkaille</b></p> <p>Tämän Yamaha-tuotteen sekä ETA-alueen ja Sveitsin takuuta koskevat yksityiskohtaiset tiedot saatte alla olevasta nettiosoitteesta. (Tulostettava tiedosto saatavissa sivustollamme.) Voitte myös ottaa yhteyttä paikalliseen Yamaha-edustajaan. *ETA: Euroopan talousalue</p>	Suomi
<p><b>Ważne: Warunki gwarancyjne obowiązujące w EOG* i Szwajcarii</b></p> <p>Aby dowiedzieć się więcej na temat warunków gwarancyjnych tego produktu firmy Yamaha i serwisu gwarancyjnego w całym EOG* i Szwajcarii, należy odwiedzić wskazaną poniżej stronę internetową (Plik gotowy do wydruku znajduje się na naszej stronie internetowej) lub skontaktować się z przedstawicielstwem firmy Yamaha w swoim kraju. * EOG — Europejski Obszar Gospodarczy</p>	Polski
<p><b>Důležité oznámení: Záruční informace pro zákazníky v EHS* a ve Švýcarsku</b></p> <p>Podrobné záruční informace o tomto produktu Yamaha a záručním servisu v celém EHS* a ve Švýcarsku naleznete na níže uvedené webové adrese (soubor k tisku je dostupný na našich webových stránkách) nebo se můžete obrátit na zastoupení firmy Yamaha ve své zemi. * EHS: Evropský hospodářský prostor</p>	Česky
<p><b>Fontos figyelmeztetés: Garancia-információk az EGT* területén és Svájcban élő vásárlók számára</b></p> <p>A jelen Yamaha termékre vonatkozó részletes garancia-információk, valamint az EGT*-re és Svájcra kiterjedő garanciális szolgáltatás tekintetében keresse fel webhelyünket az alábbi címen (a webhelyen nyomatatható fájl is található), vagy pedig lépjen kapcsolatba az országában működő Yamaha képviselői irodával. * EGT: Európai Gazdasági Térség</p>	Magyar
<p><b>Oluline märkus: Garantiteave Euroopa Majanduspiirkonna (EMP)* ja Šveitsi klientidele</b></p> <p>Täpsemate teabe saamiseks selle Yamaha toote garantii ning kogu Euroopa Majanduspiirkonna ja Šveitsi garantiiteeninduse kohta, külastage palun veebisaiti alljärgneval aadressil (meie saidil on saadaval printitav fail) või pöörduge Teie regiooni Yamaha esinduse poole. * EMP: Euroopa Majanduspiirkond</p>	Eesti keel
<p><b>Svarīgs paziņojums: garantijas informācija klientiem EEZ* un Šveicē</b></p> <p>Lai saņemtu detalizētu garantijas informāciju par šo Yamaha produktu, kā arī garantijas apkalpošanu EEZ* un Šveicē, lūdzam, apmeklējiet zemāk norādīto tīmekļa vietnes adresi (tīmekļa vietni ē pieejams drukājams fails) vai sazinieties ar jūsu valsti apkalpojošo Yamaha pārstāvniecību. * EEZ: Eiropas Ekonomikas zona</p>	Latviešu
<p><b>Dėmesio: informacija dėl garantijos pirkėjams EEE* ir Šveicarijoje</b></p> <p>Jei reikia išsamios informacijos apie šį „Yamaha“ produktą ir jo techninę priežiūrą visoje EEE* ir Šveicarijoje, apsilankykite mūsų svetainėje toliau nurodytu adresu (svetainėje yra spausdintinas failas) arba kreipkitės į „Yamaha“ atstovybę savo šaliai. *EEE — Europos ekonominė erdvė</p>	Lietuvių kalba
<p><b>Dôležité upozornenie: Informácie o záruke pre zákazníkov v EHP* a Švajčiarsku</b></p> <p>Podrobné informácie o záruke týkajúce sa tohto produktu od spoločnosti Yamaha a garančnom servise v EHP* a Švajčiarsku nájdete na webovej stránke uvedenej nižšie (na našej webovej stránke je k dispozícii súbor na tlač) alebo sa obráťte na zástupcu spoločnosti Yamaha vo svojej krajine. * EHP: Európsky hospodársky priestor</p>	Slovenčina
<p><b>Pomembno obvestilo: Informacije o garanciji za kupce v EGP* in Švici</b></p> <p>Za podrobnejše informacije o tem Yamahinem izdelku ter garancijskem servisu v celotnem EGP in Švici, obiščite spletno mesto, ki je navedeno spodaj (natisljiva datoteka je na voljo na našem spletnem mestu), ali se obrnite na Yamahinega predstavnika v svoji državi. * EGP: Evropski gospodarski prostor</p>	Slovenščina
<p><b>Важно съобщение: Информация за гаранцията за клиенти в ЕИП* и Швейцария</b></p> <p>За подробна информация за гаранцията за този продукт на Yamaha и гаранционното обслужване в паневропейската зона на ЕИП* и Швейцария или посетете посочения по-долу уеб сайт (на нашия уеб сайт има файл за печат), или се свържете с представителния офис на Yamaha във вашата страна. * ЕИП: Европейско икономическо пространство</p>	Български език
<p><b>Notificare importantă: Informații despre garanție pentru clienții din SEE* și Elveția</b></p> <p>Pentru informații detaliate privind acest produs Yamaha și serviciul de garanție Pan-SEE* și Elveția, vizitați site-ul la adresa de mai jos (fișierul imprimabil este disponibil pe site-ul nostru) sau contactați biroul reprezentanței Yamaha din țara dumneavoastră. * SEE: Spațiul Economic European</p>	Limba română
<p><b>Važna obavijest: Informacije o jamstvu za države EGP-a i Švicarske</b></p> <p>Za detaljne informacije o jamstvu za ovaj Yamahin proizvod te jamstvenom servisu za cijeli EGP i Švicarsku, molimo Vas da posjetite web-stranicu navedenu u nastavku ili kontaktirate ovlaštenog Yamahinog dobavljača u svojoj zemlji. * EGP: Europski gospodarski prostor</p>	Hrvatski

<https://europe.yamaha.com/warranty/>

For details of products, please contact your nearest Yamaha representative or the authorized distributor listed below.

Pour plus de détails sur les produits, veuillez-vous adresser à Yamaha ou au distributeur le plus proche de vous figurant dans la liste suivante.

Die Einzelheiten zu Produkten sind bei Ihrer unten aufgeführten Niederlassung und bei Yamaha Vertragshändlern in den jeweiligen Bestimmungsländern erhältlich.

Para detalles sobre productos, contacte su tienda Yamaha más cercana o el distribuidor autorizado que se lista debajo.

## NORTH AMERICA

### CANADA

**Yamaha Canada Music Ltd.**  
135 Milner Avenue, Toronto, Ontario M1S 3R1,  
Canada  
Tel: +1-416-298-1311

### U.S.A.

**Yamaha Corporation of America**  
6600 Orangethorpe Avenue, Buena Park, CA 90620,  
U.S.A.  
Tel: +1-714-522-9011

## CENTRAL & SOUTH AMERICA

### MEXICO

**Yamaha de México, S.A. de C.V.**  
Av. Insurgentes Sur 1647 Piso 9, Col. San José  
Insurgentes, Delegación Benito Juárez, México,  
D.F., C.P. 03900, México  
Tel: +52-55-5804-0600

### BRAZIL

**Yamaha Musical do Brasil Ltda.**  
Rua Fidêncio Ramos, 302 – Cj 52 e 54 – Torre B –  
Vila Olímpia – CEP 04551-010 – São Paulo/SP,  
Brazil  
Tel: +55-11-3704-1377

### ARGENTINA

**Yamaha Music Latin America, S.A.,  
Sucursal Argentina**  
Olga Cossetini 1553, Piso 4 Norte,  
Madero Este-C1107CEK,  
Buenos Aires, Argentina  
Tel: +54-11-4119-7000

### PANAMA AND OTHER LATIN AMERICAN COUNTRIES/ CARIBBEAN COUNTRIES

**Yamaha Music Latin America, S.A.**  
Edificio Torre Davivienda, Piso: 20  
Avenida Balboa, Marbella, Corregimiento de Bella  
Vista, Ciudad de Panamá, Rep. de Panamá  
Tel: +507-269-5311

## EUROPE

### THE UNITED KINGDOM/IRELAND

**Yamaha Music Europe GmbH (UK)**  
Sherbourne Drive, Tilbrook, Milton Keynes,  
MK7 8BL, U.K.  
Tel: +44-1908-366700

### GERMANY

**Yamaha Music Europe GmbH**  
Siemensstrasse 22-34, 25462 Rellingen, Germany  
Tel: +49-4101-303-0

### SWITZERLAND/LIECHTENSTEIN

**Yamaha Music Europe GmbH, Branch  
Switzerland in Thalwil**  
Seestrasse 18a, 8800 Thalwil, Switzerland  
Tel: +41-44-3878080

### AUSTRIA/CROATIA/CZECH REPUBLIC/ HUNGARY/ROMANIA/SLOVAKIA/ SLOVENIA

**Yamaha Music Europe GmbH, Branch Austria**  
Schleiergasse 20, 1100 Wien, Austria  
Tel: +43-1-60203900

### POLAND

**Yamaha Music Europe GmbH**  
Sp.z o.o. Oddział w Polsce  
ul. Wielicka 52, 02-657 Warszawa, Poland  
Tel: +48-22-880-08-88

### BULGARIA

**Dinacord Bulgaria LTD.**  
Bul. Iskarsko Schose 7 Targowski Zentar Ewropa  
1528 Sofia, Bulgaria  
Tel: +359-2-978-20-25

### MALTA

**Olimpus Music Ltd.**  
Valletta Road, Mosta MST9010, Malta  
Tel: +356-2133-2093

### NETHERLANDS/BELGIUM/ LUXEMBOURG

**Yamaha Music Europe, Branch Benelux**  
Clarissenhof 5b, 4133 AB Vianen, The Netherlands  
Tel: +31-347-358040

### FRANCE

**Yamaha Music Europe**  
7 rue Ambroise Croizat, Zone d'activités de Pariest,  
77183 Croissy-Beaubourg, France  
Tel: +33-1-6461-4000

### ITALY

**Yamaha Music Europe GmbH, Branch Italy**  
Via Tinelli N.67/69 20855 Gerno di Lesmo (MB),  
Italy  
Tel: +39-039-9065-1

### SPAIN/PORTUGAL

**Yamaha Music Europe GmbH Ibérica, Sucursal  
en España**  
Ctra. de la Coruña km. 17,200, 28231  
Las Rozas de Madrid, Spain  
Tel: +34-91-639-88-88

### GREECE

**Philippos Nakas S.A. The Music House**  
19th km. Leof. Lavriou 190 02 Peania – Attiki,  
Greece  
Tel: +30-210-6686260

### SWEDEN

**Yamaha Music Europe GmbH Germany filial  
Scandinavia**  
JA Wettergrensgata 1, 400 43 Göteborg, Sweden  
Tel: +46-31-89-34-00

### DENMARK

**Yamaha Music Denmark,  
Fillial of Yamaha Music Europe GmbH, Tyskland**  
Generatorvej 8C, ST. TH., 2860 Søborg, Denmark  
Tel: +45-44-92-49-00

### FINLAND

**F-Musiikki Oy**  
Antaksentie 4  
FI-01510 Vantaa, Finland  
Tel: +358 (0)96185111

### NORWAY

**Yamaha Music Europe GmbH Germany -  
Norwegian Branch**  
Grini Næringspark 1, 1332 Østerås, Norway  
Tel: +47-6716-7800

### ICELAND

**Hljodfaerahusid Ehf.**  
Sidumula 20  
IS-108 Reykjavik, Iceland  
Tel: +354-525-5050

### CYPRUS

**Nakas Music Cyprus Ltd.**  
Nikis Ave 2k  
1086 Nicosia  
Tel: +357-22-511080  
**Major Music Center**  
21 Ali Riza Ave. Ortakoy  
P.O.Box 475 Lefkoşa, Cyprus  
Tel: (392) 227 9213

### RUSSIA

**Yamaha Music (Russia) LLC.**  
Room 37, entrance 7, bld. 7, Kievskaya street,  
Moscow, 121059, Russia  
Tel: +7-495-626-5005

### OTHER EUROPEAN COUNTRIES

**Yamaha Music Europe GmbH**  
Siemensstrasse 22-34, 25462 Rellingen, Germany  
Tel: +49-4101-303-0

## AFRICA

**Yamaha Music Gulf FZE**  
JAFZA-16, Office 512, P.O.Box 17328,  
Jebel Ali FZE, Dubai, UAE  
Tel: +971-4-801-1500

## MIDDLE EAST

### TURKEY

**Yamaha Music Europe GmbH**  
**Merkezi Almanyā Türkiye İstanbul Şubesi**  
Mor Sumbul Sokak Varyap Meridian Business  
1.Blok No:1 113-114-115  
Bati Atasehir Istanbul, Turkey  
Tel: +90-216-275-7960

### ISRAEL

**RBX International Co., Ltd.**  
P.O Box 10245, Petach-Tikva, 49002  
Tel: (972) 3-925-6900

## OTHER COUNTRIES

**Yamaha Music Gulf FZE**  
JAFZA-16, Office 512, P.O.Box 17328,  
Jebel Ali FZE, Dubai, UAE  
Tel: +971-4-801-1500

## ASIA

### THE PEOPLE'S REPUBLIC OF CHINA

**Yamaha Music & Electronics (China) Co., Ltd.**  
2F, Yunhedasha, 1818 Xinzha-lu, Jingan-qu,  
Shanghai, China  
Tel: +86-400-051-7700

### HONG KONG

**Tom Lee Music Co., Ltd.**  
11/F, Silvercord Tower 1, 30 Canton Road,  
Tsimshatsui, Kowloon, Hong Kong  
Tel: +852-2737-7688

### INDIA

**Yamaha Music India Private Limited**  
P-401, JMD Megapolis, Sector-48, Sohna Road,  
Gurgaon-122018, Haryana, India  
Tel: +91-124-485-3300

### INDONESIA

**PT. Yamaha Musik Indonesia (Distributor)**  
Yamaha Music Center Bldg. Jalan Jend. Gatot  
Subroto Kav. 4, Jakarta 12930, Indonesia  
Tel: +62-21-520-2577

### KOREA

**Yamaha Music Korea Ltd.**  
11F, Prudential Tower, 298, Gangnam-daero,  
Gangnam-gu, Seoul, 06253, Korea  
Tel: +82-2-3467-3300

### MALAYSIA

**Yamaha Music (Malaysia) Sdn. Bhd.**  
No.8, Jalan Perbandaran, Kelana Jaya, 47301  
Petaling Jaya, Selangor, Malaysia  
Tel: +60-3-78030900

### SINGAPORE

**Yamaha Music (Asia) Private Limited**  
Block 202 Hougang Street 21, #02-00,  
Singapore 530202, Singapore  
Tel: +65-6740-9200

### TAIWAN

**Yamaha Music & Electronics Taiwan Co., Ltd.**  
2F, No.1, Yuanfong Rd., Banqiao Dist.,  
New Taipei City 22063, Taiwan (R.O.C.)  
Tel: +886-2-7741-8888

### THAILAND

**Siam Music Yamaha Co., Ltd.**  
3, 4, 15, 16th Fl., Siam Motors Building,  
891/1 Rama 1 Road, Wangmai,  
Pathumwan, Bangkok 10330, Thailand  
Tel: +66-2215-2622

### VIETNAM

**Yamaha Music Vietnam Company Limited**  
15th Floor, Nam A Bank Tower, 201-203 Cach  
Mang Thang Tam St., Ward 4, Dist.3,  
Ho Chi Minh City, Vietnam  
Tel: +84-28-3818-1122

### OTHER ASIAN COUNTRIES

[https://asia-latinamerica-mea.yamaha.com/  
index.html](https://asia-latinamerica-mea.yamaha.com/index.html)

## OCEANIA

### AUSTRALIA

**Yamaha Music Australia Pty. Ltd.**  
Level 1, 80 Market Street, South Melbourne,  
VIC 3205 Australia  
Tel: +61-3-9693-5111

### NEW ZEALAND

**Music Works LTD**  
P.O. BOX 6246 Wellesley, Auckland 4680,  
New Zealand  
Tel: +64-9-634-0099

### COUNTRIES AND TRUST

### TERRITORIES IN PACIFIC OCEAN

[https://asia-latinamerica-mea.yamaha.com/  
index.html](https://asia-latinamerica-mea.yamaha.com/index.html)

Yamaha Global Site  
<https://www.yamaha.com/>

Yamaha Downloads  
<https://download.yamaha.com/>

Manual Development Group  
© 2020 Yamaha Corporation  
Published 02/2020 MWMA\*.\*-\*\*A0

VCR9660