



AVANT GRAND

NU1XA

Owner's Manual
Mode d'emploi
Manual de instrucciones

Before using this instrument, be sure to read "PRECAUTIONS" on pages 4–5.

Avant d'utiliser cet instrument, lisez attentivement la section « PRÉCAUTIONS D'USAGE » aux pages 4–5.

Antes de utilizar el instrumento, lea la sección "PRECAUCIONES", en las páginas 4–5.

ENGLISH

FRANÇAIS

ESPAÑOL

EN

FR

ES

FCC INFORMATION (U.S.A.)

1. IMPORTANT NOTICE: DO NOT MODIFY THIS UNIT!

This product, when installed as indicated in the instructions contained in this manual, meets FCC requirements. Modifications not expressly approved by Yamaha may void your authority, granted by the FCC, to use the product.

2. IMPORTANT:

When connecting this product to accessories and/or another product use only high quality shielded cables. Cable/s supplied with this product MUST be used. Follow all installation instructions. Failure to follow instructions could void your FCC authorization to use this product in the USA.

3. NOTE:

This product has been tested and found to comply with the requirements listed in FCC Regulations, Part 15 for Class "B" digital devices. Compliance with these requirements provides a reasonable level of assurance that your use of this product in a residential environment will not result in harmful interference with other electronic devices. This equipment generates/uses radio frequencies and, if not installed and used according to the instructions found in the users manual, may cause interference harmful to the operation of other electronic devices. Compliance with FCC regulations does not guarantee that interference will not occur in all installations. If this product is found to be the source of interference, which can be determined by turning the unit "OFF" and "ON", please try to eliminate the problem by using one of the following measures:

- Relocate either this product or the device that is being affected by the interference.
- Utilize power outlets that are on different branch (circuit breaker or fuse) circuits or install AC line filter/s.
- In the case of radio or TV interference, relocate/reorient the antenna. If the antenna lead-in is 300 ohm ribbon lead, change the lead-in to co-axial type cable.

If these corrective measures do not produce satisfactory results, please contact the local retailer authorized to distribute this type of product. If you cannot locate the appropriate retailer, please contact Yamaha Corporation of America, 6600 Orangethorpe Avenue, Buena Park, CA 90620, U.S.A.

The above statements apply ONLY to those products distributed by Yamaha Corporation of America or its subsidiaries.

(529-M04 FCC class B YCA 02)

COMPLIANCE INFORMATION STATEMENT (Supplier's declaration of conformity procedure)

Responsible Party: Yamaha Corporation of America
Address: 6600 Orangethorpe Avenue, Buena Park, CA 90620, U.S.A.
Telephone: 714-522-9011
Type of Equipment: Hybrid Piano
Model Name: NU1XA

This device complies with Part 15 of the FCC Rules.

Operation is subject to the following two conditions:

- 1) this device may not cause harmful interference, and
- 2) this device must accept any interference received including interference that may cause undesired operation.

(529-M02 FCC sdoc YCA 02)

The model number, serial number, power requirements, etc., may be found on or near the name plate, which is at the bottom of the unit. You should note this serial number in the space provided below and retain this manual as a permanent record of your purchase to aid identification in the event of theft.

Model No.

Serial No.

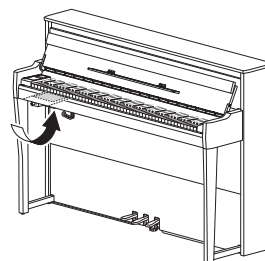

The name plate is located on the bottom of the keyboard.

(1003-M06 plate bottom en 01)

Information for users on collection and disposal of old equipment:



This symbol on the products, packaging, and/or accompanying documents means that used electrical and electronic products should not be mixed with general household waste.

For proper treatment, recovery and recycling of old products, please take them to applicable collection points, in accordance with your national legislation.

By disposing of these products correctly, you will help to save valuable resources and prevent any potential negative effects on human health and the environment which could otherwise arise from inappropriate waste handling.

For more information about collection and recycling of old products, please contact your local municipality, your waste disposal service or the point of sale where you purchased the items.

For business users in the European Union:

If you wish to discard electrical and electronic equipment, please contact your dealer or supplier for further information.

Information on Disposal in other Countries outside the European Union:

This symbol is only valid in the European Union. If you wish to discard these items, please contact your local authorities or dealer and ask for the correct method of disposal.

(58-M02 WEEE en 01)

Informations concernant la collecte et le traitement des déchets d'équipements électriques et électroniques



Le symbole sur les produits, l'emballage et/ou les documents joints signifie que les produits électriques ou électroniques usagés ne doivent pas être mélangés avec les déchets domestiques habituels.

Pour un traitement, une récupération et un recyclage appropriés des déchets d'équipements électriques et électroniques, veuillez les déposer aux points de collecte prévus à cet effet, conformément à la réglementation nationale.

En vous débarrassant correctement des déchets d'équipements électriques et électroniques, vous contribuerez à la sauvegarde de précieuses ressources et à la prévention de potentiels effets négatifs sur la santé humaine qui pourraient advenir lors d'un traitement inapproprié des déchets.

Pour plus d'informations à propos de la collecte et du recyclage des déchets d'équipements électriques et électroniques, veuillez contacter votre municipalité, votre service de traitement des déchets ou le point de vente où vous avez acheté les produits.

Pour les professionnels dans l'Union européenne :

Si vous souhaitez vous débarrasser des déchets d'équipements électriques et électroniques, veuillez contacter votre vendeur ou fournisseur pour plus d'informations.

Informations sur la mise au rebut dans d'autres pays en dehors de l'Union européenne :

Ce symbole est seulement valable dans l'Union européenne. Si vous souhaitez vous débarrasser de déchets d'équipements électriques et électroniques, veuillez contacter les autorités locales ou votre fournisseur et demander la méthode de traitement appropriée.

(58-M02 WEEE fr 01)

Información para usuarios sobre la recogida y eliminación de los equipos antiguos



Este símbolo en los productos, embalajes y documentos anexos significa que los productos eléctricos y electrónicos no deben mezclarse con los desperdicios domésticos normales.

Para el tratamiento, recuperación y reciclaje apropiados de los productos antiguos, llévelos a puntos de reciclaje correspondientes, de acuerdo con la legislación nacional.

Al deshacerse de estos productos de forma correcta, ayudará a ahorrar recursos valiosos y a impedir los posibles efectos desfavorables en la salud humana y en el entorno que de otro modo se producirían si se trataran los desperdicios de modo inapropiado.

Para obtener más información acerca de la recogida y el reciclaje de los productos antiguos, póngase en contacto con las autoridades locales, con el servicio de eliminación de basuras o con el punto de venta donde adquirió los artículos.

Para los usuarios empresariales de la Unión Europea:

Si desea desechar equipos eléctricos y electrónicos, póngase en contacto con su vendedor o proveedor para obtener más información.

Información sobre la eliminación en otros países fuera de la Unión Europea:

Este símbolo solo es válido en la Unión Europea. Si desea desechar estos artículos, póngase en contacto con las autoridades locales o con el vendedor y pregúnteles el método correcto.

(58-M02 WEEE es 01)

PRECAUTIONS

PLEASE READ CAREFULLY BEFORE PROCEEDING

Especially in the case of children, a guardian should provide guidance on how to properly use and handle the product before actual use. Please keep this manual in a safe and handy place for future reference.



WARNING

Always follow the basic precautions listed below to avoid the possibility of serious injury or even death from electrical shock, short-circuiting, damages, fire or other hazards. These precautions include, but are not limited to, the following:

Power supply

- Do not place the power cord near heat sources such as heaters or radiators. Also, do not excessively bend or otherwise damage the cord, or place heavy objects on it.
- Do not touch the product or the power plug during an electrical storm.
- Use only the correct voltage specified for the product. The required voltage is printed on the name plate of the product.
- Use only the supplied or the specified AC adaptor (page 103)/power cord. Do not use the AC adaptor/power cord for other devices.
- Check the power plug periodically and remove any dirt or dust which may have accumulated on it.
- Insert the power plug firmly all the way into the AC outlet. Using the product when it is not plugged in sufficiently can cause dust to accumulate on the plug, possibly resulting in fire or skin burns.
- When setting up the product, make sure that the AC outlet you are using is easily accessible. If some trouble or malfunction occurs, immediately turn off the power switch and disconnect the plug from the outlet. Even when the power switch is turned off, as long as the power cord is not unplugged from the wall AC outlet, the product will not be disconnected from the power source.
- Do not connect the product to an electrical outlet using a multi-plug outlet extender. Doing so can result in lower sound quality, or possibly cause overheating in the outlet.
- When disconnecting the power plug, always hold the plug itself and not the cord. Pulling by the cord can damage it and cause electric shocks or a fire.
- If not using the product for long periods of time, be sure to pull the power plug from the AC outlet.

Do not disassemble

- This product contains no user-serviceable parts. Do not attempt to disassemble the internal parts or modify them in any way.

Water warning

- Do not expose the product to rain, use it near water or in damp or wet conditions, or place on it any containers (such as vases, bottles or glasses) containing liquids which might spill into any openings or places where water may drop. A liquid such as water getting into the product may cause a fire, electric shocks, or malfunctions.
- Use the AC adaptor indoors only. Do not use in any wet environments.
- Never insert or remove a power plug with wet hands.

Fire warning

- Do not place any burning items or open flames near the product, since they may cause a fire.

Wireless unit

- Radio waves from this product may affect electro-medical devices, such as a heart pacemaker implant or defibrillator implant.
 - Do not use the product near medical devices or inside medical facilities. Radio waves from this product may affect electro-medical devices.
 - Do not use the product within 15 cm (6 in.) of persons with a heart pacemaker implant or a defibrillator implant.

Using the bench (if included)

- Do not place the bench in an unstable position where it might accidentally fall over.
- Do not play carelessly with or stand on the bench. Using it as a tool or stepladder or for any other purpose might result in accident or injury.
- Only one person should sit on the bench at a time, in order to prevent the possibility of accident or injury.
- If the bench screws become loose due to extensive long-term use, tighten them periodically using the specified tool in order to prevent the possibility of accident or injury.
- Keep special watch over any small children so that they don't fall off the rear of the bench. Since the bench does not have a backrest, unsupervised use may result in accident or injury.

If you notice any abnormality

- If any of the following problems occur, immediately turn off the power switch and disconnect the power plug from the outlet. Finally have the device inspected by Yamaha service personnel.
 - The power cord or plug becomes frayed or damaged.
 - Unusual smells or smoke are emitted.

- Some object, or water has been dropped into the product.
- There is a sudden loss of sound during use of the product.
- Cracks or other visible damage appear on the product.



CAUTION

Always follow the basic precautions listed below to avoid the possibility of physical injury to you or others, or damage to the instrument or other property. These precautions include, but are not limited to, the following:

Location

- Do not place the product in an unstable position or a location with excessive vibration, where it might accidentally fall over and cause injury.
- Do not go near the product during an earthquake. Strong shaking during an earthquake could cause the product to move or tip over, resulting in damage to the product or its parts, and possibly causing injury.
- Before moving the piano, consult with a specialist experienced in moving pianos. Pianos are extremely heavy. When moving a piano, there is a risk of causing back injury and scratching the floor.
- Since this product is very heavy, make sure that a sufficient number of people are on hand to help, so you can lift and move it safely and easily. Attempting to lift or move the instrument by force may damage your back, result in other injury, or cause damage to the instrument itself.
- Before moving the product, remove all connected cables, to prevent damage to the cables or injury to anyone who might trip over them.
- Though the wooden parts of the product have been designed and produced with care concerning the environment and human health, in some rare instances customers may sense an unusual odor or develop irritation in the eyes, due to the coating material and adhesive. To avoid this, we recommend that you observe the following:
 1. Specially ventilate the room for several days after unpacking and installing the product, since it has been packed in airtight conditions in order to maintain quality during transportation.
 2. If the room housing the product is small, continue to ventilate it normally, either daily or periodically.
 3. If you have left the product in a closed room for a long time under high temperature, ventilate the room, then lower the temperature if possible before using the product.

Connections

- Before connecting the product to other devices, turn off the power for all devices. Before turning the power on or off for all devices, set all volume levels to minimum.

- Be sure to set the volumes of all devices at their minimum levels and gradually raise the volume controls while playing the product to set the desired listening level.

Handling

- Do not insert your finger or hand in any gaps on the fall board or product. Also take care that the fall board does not pinch your finger.
- Do not insert foreign materials such as metal or paper into any openings or gaps of the product. Failure to observe this may cause a fire, electric shocks, or malfunctions.
- Do not apply excessive force when closing the fall board. A fall board equipped with the SOFT-CLOSE™ mechanism closes the cover slowly. Applying excessive force to the fall board when closing it could damage the SOFT-CLOSE™ mechanism, and possibly result in injury to your hands and fingers caught under the closing fall board.
- Do not rest your weight on, or place heavy objects on the product, and do not use excessive force on the buttons, switches or connectors.
- Keep small parts out of the reach of infants. Your children may accidentally swallow them.
- Do not use the product or headphones for a long period of time at a high or uncomfortable volume level, since this can cause permanent hearing loss. If you experience any hearing loss or ringing in the ears, consult a physician.
- Remove the power plug from the AC outlet before cleaning the unit. Failure to observe this may cause electric shocks.

Using the bench (if included)

- For benches that can be adjusted, do not adjust the bench height while sitting on the bench, since this can cause excessive force applied to the adjustment mechanism, possibly resulting in damage to the mechanism or even injury.
- Do not place your hand between moving parts. Otherwise, your hand could be pinched between the parts, possibly resulting in injury.

Yamaha cannot be held responsible for damage caused by improper use or modifications to the product, or data that is lost or destroyed.

Always turn the power off when the instrument is not in use.

Even when the [ϕ] (Standby/On) switch is in standby status (power lamp is off), electricity is still flowing to the instrument at the minimum level.

When you are not using the instrument for a long time, make sure you unplug the power cord from the wall AC outlet.

(DMI-11)

NOTICE

To avoid the possibility of malfunction/ damage to the product, damage to data, or damage to other property, follow the notices below.

■ Handling

- Do not connect this product to a public Wi-Fi and/or Internet service directly. Only connect this product to the Internet through a router with strong password protections. Consult your router manufacturer for information on optimum security practices.
- Do not use this product in the vicinity of a TV, radio, stereo equipment, mobile phone, or other electric devices. Otherwise, this product or the other device may generate noise.
- When you use the product along with an app on your smart device, such as a smartphone or tablet, we recommend that you enable “Airplane Mode” on the device to avoid noise caused by communication. When turning on airplane mode, Wi-Fi or *Bluetooth*[®] settings may be turned off. Make sure that the setting is turned on before use.
- Do not expose the product to excessive dust or vibrations, or extreme cold or heat (such as in direct sunlight, near a heater, or in a car during the day) to prevent the possibility of disfiguration, damage to the internal components or unstable operation. (Verified operating temperature range: 5° – 40°C, or 41° – 104°F.)
- Do not place vinyl, plastic or rubber objects on the product, since this might discolor the product.
- Bumping the surface of the product with metal, porcelain, or other hard objects can cause the finish to crack or peel. Use caution.

■ Maintenance

- When cleaning the product, use a soft and dry (or slightly damp) cloth. Do not use paint thinners, solvents, alcohol, cleaning fluids, or chemical-impregnated wiping cloths.
- Gently remove dust and dirt with a soft cloth. Do not wipe too hard since small particles of dirt can scratch the instrument’s finish.
- During extreme changes in temperature or humidity, condensation may occur and water may collect on the surface of the product. If water is left, the wooden parts may absorb the water and be damaged. Make sure to wipe any water off immediately with a soft cloth.

■ Saving data

- Some of the data of this instrument (page 92) and the Song data saved to the internal memory of this instrument (page 46) are retained when the power is turned off. However, the saved data may be lost due to some failure, an operation mistake, etc. Save your important data onto USB flash drive or an external device such as a computer (pages 60, 92). Before using a USB flash drive, make sure to refer to page 64.
- To protect against data loss through USB flash drive damage, we recommend that you save your important data onto spare USB flash drive or an external device such as a computer as backup data.

Information

■ About copyrights

- The copyright of the “content”^{*1} installed in this product belongs to Yamaha Corporation or its copyright holder. Except as permitted by copyright laws and other relevant laws, such as copying for personal use, it is prohibited to “reproduce or divert”^{*2} without the permission of the copyright holder. When using the content, consult with a copyright expert. If you create music or perform with the contents through the original use of the product, and then record and distribute them, the permission of Yamaha Corporation is not required regardless of whether the distribution method is paid or free of charge.

*1: The word “content” includes a computer program, audio data, Accompaniment Style data, MIDI data, waveform data, voice recording data, music score, and score data, etc.

*2: The phrase “reproduce or divert” includes taking out the content itself in this product, or recording and distributing it without changes in a similar manner.

■ About functions/data bundled with the product

- Some of the preset songs have been edited for length or arrangement, and may not be exactly the same as the original.
- The bitmap fonts used in this product have been provided by and are the property of Ricoh Co., Ltd.

■ About this manual

- The illustrations and LCD screens as shown in this manual are for instructional purposes only.
- Windows is a registered trademark of Microsoft[®] Corporation in the United States and other countries.
- Wi-Fi is a registered trademark of Wi-Fi Alliance[®].
- The *Bluetooth*[®] word mark and logos are registered trademarks owned by Bluetooth SIG, Inc. and any use of such marks by Yamaha Corporation is under license.



- The company names and product names in this manual are the trademarks or registered trademarks of their respective companies.

■ Tuning

- Unlike an acoustic piano, this instrument does not need to be tuned by an expert (although the pitch can be user-adjusted to match other instruments). However, since the keyboard mechanism of this instrument is the same as that of an actual piano, the mechanism may change over years of use. If this occurs or causes problems in performance, contact your Yamaha dealer.

Transporting/Installing

If you move to another location, transport the instrument horizontally. Do not subject the instrument to excessive vibration or shock.

CAUTION

When moving the instrument, always hold the bottom of the keyboard unit and the handgrips of the rear side. Be sure not to hold the headphone jack box. Improper handling can result in damage to the instrument or personal injury.

NOTICE

When moving the instrument, rotate the adjuster until it separates from the floor surface. Failure to do so may damage the floor surface.

Place the instrument away from the wall by at least 10 cm to optimize and enhance the sound effect. If you find the instrument shaky or unstable after installing, insert the included felt strips. For details, refer to the instructions supplied with the felt strips.

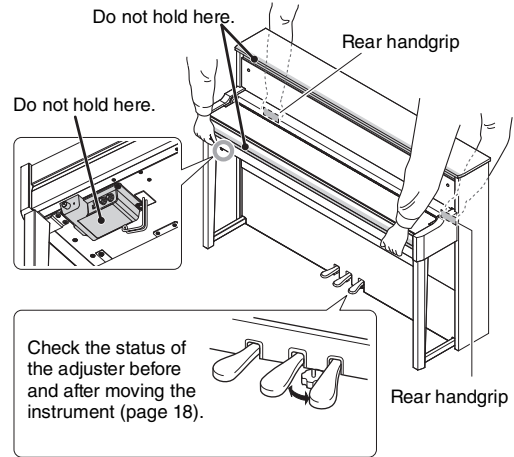

Contents

PRECAUTIONS	4
NOTICE	6
Information	6
Transporting/Installing	7
About the Manuals	9
Supplied with the instrument	9
Available on the website.....	9
Included Accessories	9
Features	10

Panel Controls and Terminals	12
Overview	12
Control Panel.....	13
Playing the Keyboard	14
Opening/Closing the Fallboard and the Music Rest	14
Turning the Power On/Off	15
Adjusting the Master Volume	17
Using Headphones.....	17
Using the Pedals	18
Basic Operations	20

Enjoying the Piano Performance	22
Selecting two Grand Piano Voices from the panel directly	22
Customizing the Sound and the Touch Sensitivity of Piano Voices (Piano Room)	23
Playing Various Musical Instrument Sounds (Voices)	26
Selecting Voices.....	26
Listening to the Voice Demos.....	28
Enhancing and Customizing the Sound	29
Playing Duo	32
Using the Metronome	34
Playing Back Songs	36
Song Playback	37
Playing a One-hand Part — Part Cancel Function (MIDI Songs)	40
Playing Back a Song Repeatedly	41
Adjusting the Volume Balance	44
Useful Playback Functions	45

Recording Your Performance	46
Recording Methods	46
Quick MIDI Recording	47
MIDI Recording — Independent Tracks	49
MIDI Recording to the USB Flash Drive.....	51
Audio Recording to the USB Flash Drive	52
Other Recording Techniques	53

Handling Song Files	57
Song Types and File Operation Limitations	57
Basic Song File Operation.....	58
Deleting Song Files — Delete	59
Copying Song Files — Copy	60
Moving Song Files — Move	60
Converting a MIDI Song to an Audio Song during Playback — MIDI to Audio	61
Renaming Song Files — Rename	61

Connecting to Other Devices	62
Connectors	62
Connecting to an Audio Player ([AUX IN] jack)	63
Using an External Speaker System for Playback (AUX OUT [L/L+R]/[R] jacks).....	63
Connecting USB Devices ([USB TO DEVICE] Terminal)	64
Connecting External MIDI Devices (MIDI Terminals).....	65
Connecting to a Computer	65
Connecting to a Smart Device.....	67
Using the Smart Device App “Smart Pianist”	70

Detailed Settings (Menu Display)	76
Common Operations in the Menu Displays.....	76
Voice Menu	77
Song Menu	81
Metronome Menu	84
Recording Menu	84
System Menu	85

Appendix	94
Voice List.....	94
Song List	97
Message List	98
Troubleshooting.....	100
Specifications	102
Index.....	104

Thank you for purchasing this Yamaha AvantGrand!

This instrument is a hybrid piano that combines Yamaha know-how accumulated over many years of making acoustic pianos with innovative digital technology.

In order to make the most of the performance potential and features of the instrument, please read the manuals thoroughly, and keep them in a handy place for later reference.

About the Manuals

This instrument has the following manuals.



Supplied with the instrument

- **Owner's Manual (this book)**

Explains the functions of the instrument and how to use it.



Available on the website

- **Smart Pianist User Guide**

Explains how to connect a smart device to use the smart device app "Smart Pianist" (page 70) with linking this instrument.

- **Computer-related Operations**

Explains how to connect this instrument to a computer and how to send and receive data.

- **MIDI Reference**

Contains the MIDI-related information.

To obtain these manuals, access the Yamaha website below:

Yamaha Downloads

<https://download.yamaha.com/>

Enter the model name for searching the desired manuals.



Included Accessories

- Owner's Manual (this book) x1
- "50 Classical Music Masterpieces" (Music Book) x1
- Online Member Product Registration x1
- Felt key cover x1
- AC adaptor* x1
- Power cord* x1
- Headphone hanger x1
See page 17 for installation instructions.
- Attachment screws for headphone hanger x2
- Felt strip set x1
To be used if the main unit is wobbly or unstable. For details, refer to the instructions supplied with the felt strips.
- Bench* x1

* May not be included depending on your area. Check with your Yamaha dealer.



Smart device application – "Smart Pianist" (page 70)

The Smart Pianist app not only gives you convenient and intuitive operation of the built-in functions,

such as Voice selection and metronome control from your smart device, but also lets you view the sheet music of the built-in Songs and Songs you've recorded on the screen.

<https://www.yamaha.com/2/apps/>

For details on how to use the app, refer to the "Smart Pianist User Guide" on the website.

Features

The AvantGrand NU1XA is the culmination of over 100 years of piano-making experience combined the latest technology. Enjoy the uniquely satisfying experience of playing an acoustic piano along with advanced digital features to your heart's content.

Full-scale piano performance



Dedicated upright piano action for authentic playing comfort

The AvantGrand NU1XA is equipped with a special upright piano action identical to that of an acoustic piano, where the action is triggered when the keys are played and the hammers move. This allows you to enjoy a wide range of playing styles and expressive techniques, from delicate to powerful, as if you were playing an actual acoustic piano.



Two world-renowned concert grand pianos

▶▶ page 22

All models feature piano sounds created with samples of the Yamaha CFX flagship concert grand piano and the famed Vienna-made Bösendorfer grand piano. The sound of the Yamaha CFX is powerful, sparkling and with a rich bass resonance. On the other hand, the Bösendorfer sound is soft and deep in the mid to bass range and beautiful for pianissimo parts. You can select the one that best matches the music you want to play.

* Bösendorfer is a subsidiary company of Yamaha.



Piano Room feature for adjusting touch and resonance

▶▶ page 23

From the Piano Room displays, you can adjust various parameters such as string resonance and touch response. You can also listen to the demo for VRM, which reproduces luxurious string and soundboard resonance, and the demo for Grand Expression Modeling, which recreates the subtle changes in the sound that respond to your touch.

- **VRM effect for reproducing the distinctive reverberation of a grand piano**

The VRM function on all models simulates the luscious resonance effect on acoustic pianos—where the sound of one string causes sympathetic vibration in other strings and the soundboard. You can vary the sound expressively by changing the timing of your pressing the keys, and the timing and depth of your pressing the pedal.

- **Grand Expression Modeling for superbly expressive sound**

On an actual acoustic piano, subtle changes in the sound can be produced by changing your playing touch from when you press a key to when you release it. The Grand Expression Modeling technology recreates these subtle changes in the sound that respond to your touch. This allows you to add accents by playing strongly or add resonance by playing softly to produce superbly expressive sound.



Realistic feeling of being immersed in the sound —even when using headphones

▶▶ page 18

When headphones are connected, the sounds of the CFX and Bösendorfer automatically switch to binaural sampling sound—which gives the impression of being immersed in the sound, as if it was actually emanating from the piano. When other piano Voices are selected, the Stereophonic Optimizer effect reproduces a natural sound distance.

Convenient performance functions



Preset Songs for effective practicing

▶▶ page 36

Also built into this instrument are 50 classical music masterpieces, plus 303 lesson Songs for mastering the piano. You can simply enjoy listening to these built-in Songs, or use them for separate right-hand/left-hand practicing.* The 303 lesson Songs consist of practice pieces taken from various standard piano instruction manuals, including “The Virtuoso Pianist.”

*The part on/off function is available only for MIDI songs that have both right- and left-hand parts.



Two recording methods

▶▶ page 46

The instrument lets you save your performance to internal memory or a commercially available USB flash drive. You can record your performance using one of two methods, MIDI or Audio recording, according to your needs. MIDI recording is ideal for making independent tracks—for example, recording a right-hand part to Track 1 first, and then a left-hand part to Track 2—allowing you to create pieces that would be difficult to play live with both hands together. Audio recording on the other hand, saves recorded data in stereo, CD-quality WAV format to a USB flash drive, for storing to computer and playing on portable music players.



Connecting to a Smart Device

▶▶ page 67

By connecting this instrument to a smart device such as smart phone or tablet, you can enjoy compatible smart device apps. In addition, you can input the audio from a Bluetooth-equipped device such as a smart device to this instrument* and hear it through the built-in speakers of the instrument.

* The instrument is equipped with Bluetooth functionality. However, the country where the product was purchased may not support Bluetooth. See page 67 for details.

Fortepiano Voices—authentic classical period piano sounds

All models feature authentic sounds created with samples of actual fortepianos—pianos which were made in the era of Mozart, Beethoven and Chopin. Enjoy performing with the actual sounds used in the era that classical music masterpieces were composed.

Refer to page 26 for selecting Voices.

*The fortepiano shown in the picture is from the collection of at the Hamamatsu Museum of Musical Instruments.



Panel Controls and Terminals

Overview

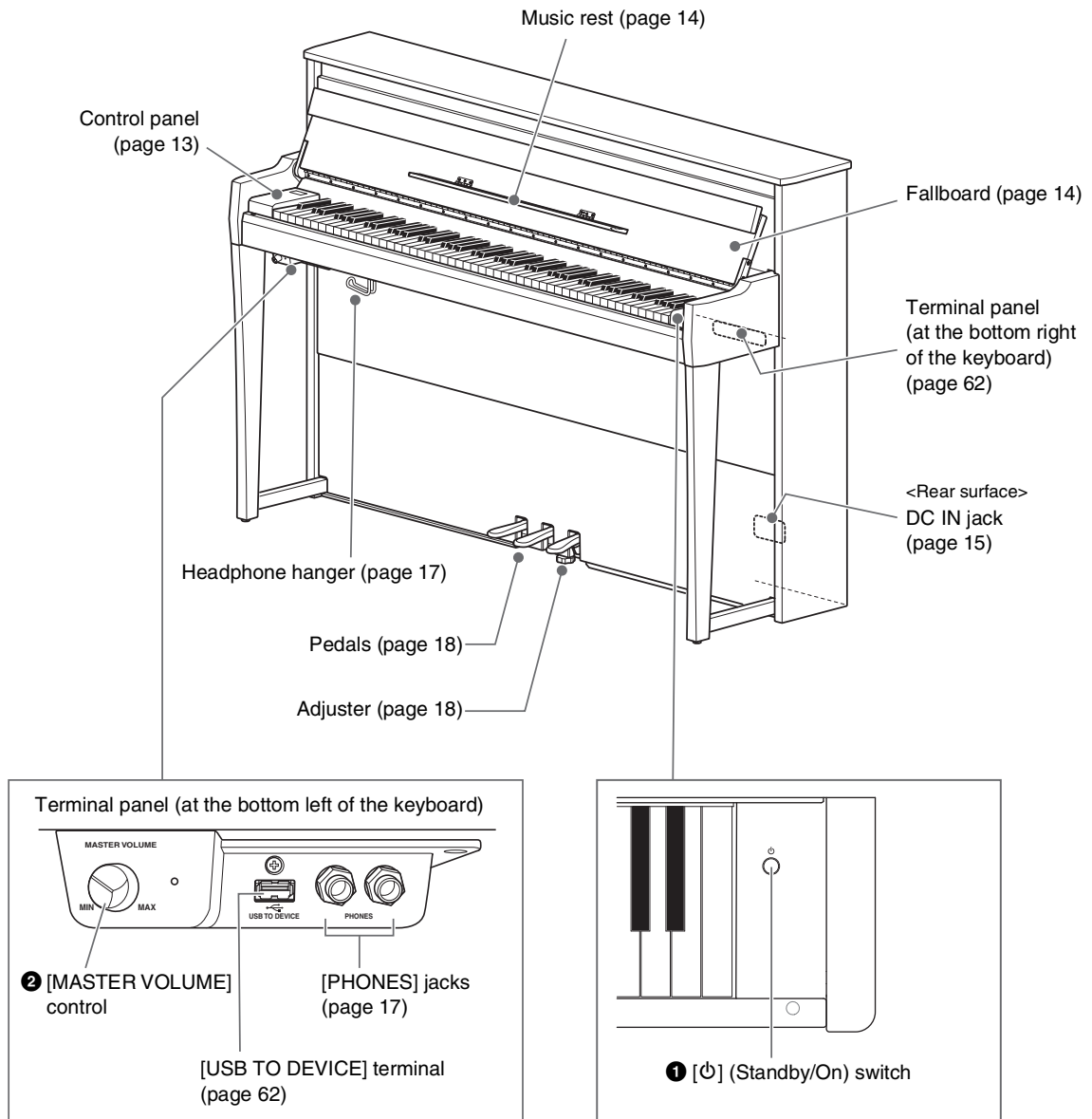

❶ [ϕ] (Standby/On) switch (page 15)

For turning the power on or setting it to standby.

❷ [MASTER VOLUME] control (page 17)

For adjusting the overall volume.

Control Panel

The buttons of the control panel are illuminated by backlight when the power is turned on (page 16). Although the backlight automatically turns off after a while (page 89), you can turn it on by simply touching the control panel.

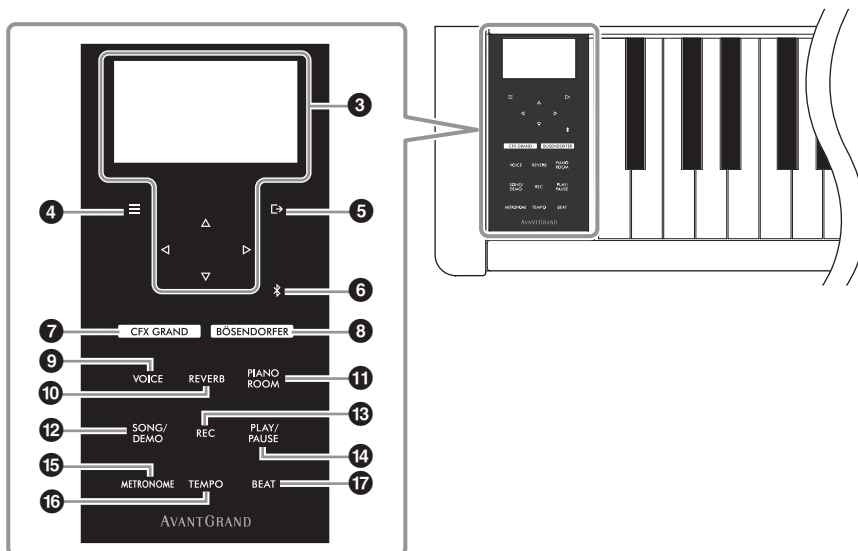

3 [Δ]/[∇]/[\triangleleft]/[\triangleright] buttons, display (page 20)

Use the buttons to select an item or set a value in the display. Note that touching the display cannot be used to perform any operations.

4 [\equiv] (Menu) button (page 76)

Pressing this button alternates the displays among the menus: “Voice,” “Song,” “Metronome/Rhythm,” “Recording” and “System”—from which you can make detailed settings for the related functions.

5 [\rightarrow] (Exit) button (page 21)

Pressing this button exits from the current display, or returns to the Voice or Song display.

6 [\ast] (Bluetooth) button (page 68)

Used for connecting to a Bluetooth-equipped device such as a smart device.

Bluetooth capability

Depending on the country in which you purchased the product, the instrument may not have Bluetooth capability. If the Bluetooth logo is shown or printed on the control panel, this means that the product is equipped with Bluetooth functionality.

7 [CFX GRAND] button (page 22)

For selecting the “CFX Grand” Voice.

8 [BÖSENDORFER] button (page 22)

For selecting the “Bösendorfer” Voice.

9 [VOICE] button (page 26)

Calls up the Voice group list for selecting the sound to play on the keyboard.

10 [REVERB] button (page 29)

Calls up the Reverb type list for selecting a Reverb type to add reverberation to the sound.

11 [PIANO ROOM] button (page 23)

Calls up the Piano Room display where you can select an optimum piano sound and adjust the touch response.

12 [SONG/DEMO] button (page 37)

Calls up the Song list for selecting a Preset Song or recorded performance to play back or edit.

13 [REC] button (page 46)

For recording your keyboard performance.

14 [PLAY/PAUSE] button (page 37)

For alternately playing back and pausing the Preset Songs or your recorded performance.

15 [METRONOME] button (page 34)

For using the metronome function.

16 [TEMPO] button (page 34)

Sets the metronome and Song tempo.

17 [BEAT] button (page 35)

Sets the time signature of the metronome.

Playing the Keyboard

Opening/Closing the Fallboard and the Music Rest

To raise the fallboard and the music rest

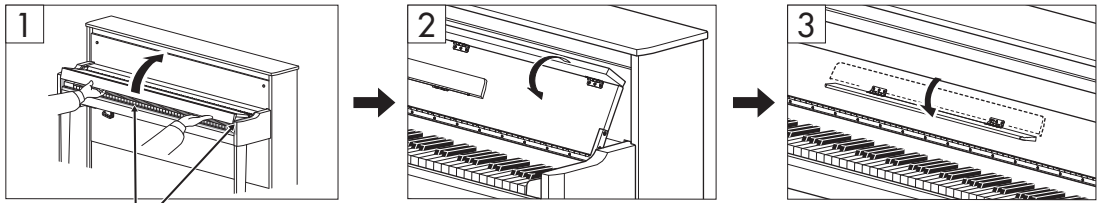

CAUTION

Be careful to avoid catching your fingers between the fallboard and the instrument.

- 1 With both hands, hold the hand grip, then lift and open the fallboard.
- 2 Fold down the top of the fallboard.
- 3 Open the music rest.

To lower the fallboard and the music rest

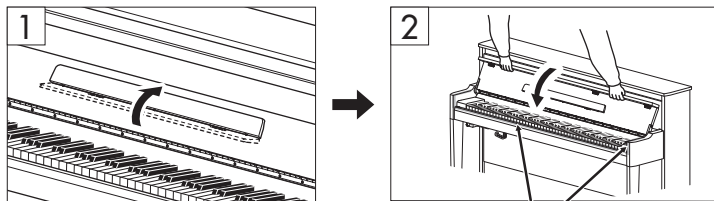

CAUTION

Be careful to avoid catching your fingers between the fallboard and the instrument.

- 1 **Close the music rest.**
If you omit this operation and close the fallboard, the music rest will hit the keyboard and may result in damage.
- 2 **With both hands, open the folded top of the fallboard, and close it gently.**
The fall board is equipped with the special SOFT-CLOSE™ mechanism which closes the cover slowly.



CAUTION

- Hold the fallboard with both hands when opening or closing it. Do not release it until it is fully opened or closed. Be careful to avoid catching fingers (yours or others, especially children's) between the fallboard and the unit.
- Do not apply excessive force when closing the fallboard. Applying excessive force to the fallboard when closing it could damage the SOFT-CLOSE™ mechanism, and possibly result in injury to your hands and fingers caught under the closing fallboard.
- Do not place anything (such as metal objects or pieces of paper) on top of the fallboard. Small objects placed on the fallboard may fall inside the unit when the fallboard is opened and may be nearly impossible to remove. Once inside, they could cause electric shock, short circuit, fire or other serious damage to the instrument.

Turning the Power On/Off

1 Connect the power cord in the order shown in the illustration.

The [DC IN] terminal is located on the lower rear side of the main unit.

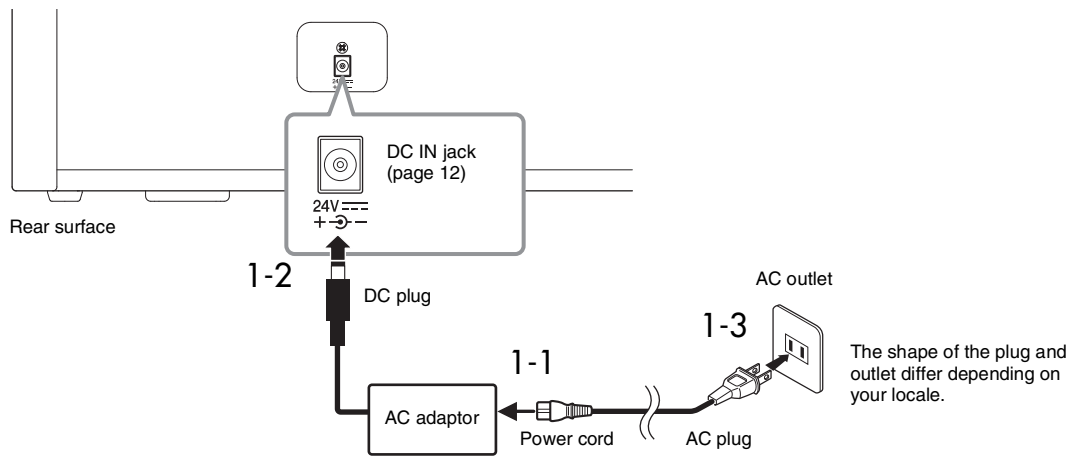

WARNING

- Use only the supplied or the specified AC adaptor (page 103)/power cord. Do not use the AC adaptor/power cord for other devices.
- When setting up the product, make sure that the AC outlet you are using is easily accessible. If some trouble or malfunction occurs, immediately turn off the power switch and disconnect the plug from the outlet.

NOTE

When disconnecting the power cord/AC adaptor, first turn off the power, then follow this procedure in reverse order.

2 Turn down the [MASTER VOLUME] control to “MIN.”

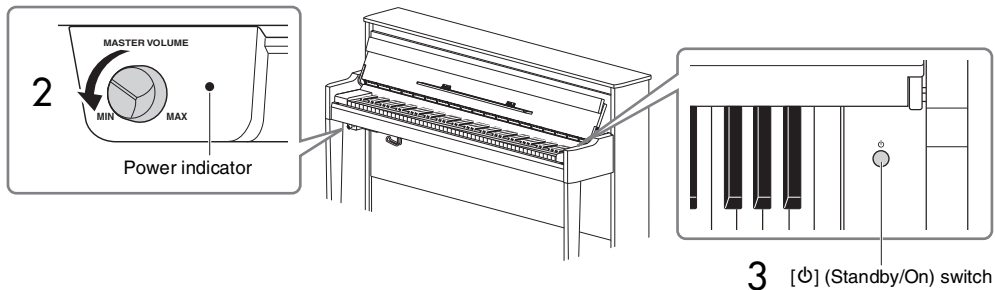

3 Press the [⏻] (Standby/On) switch on the right of the keyboard to turn the power on.

The display located at the left of the keyboard and the power indicator at the right of the [MASTER VOLUME] control both light up.

NOTICE

Do not press any keys, buttons or pedals until the instrument has completely started up (roughly five seconds after turning on the switch). Doing so may cause some keys to not play normally or some other malfunction to occur.

4 Play the keyboard.

While playing the keyboard, adjust the volume level by using the [MASTER VOLUME] control located at the left of the panel.

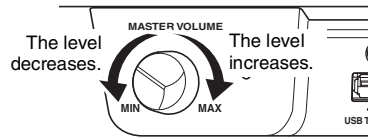
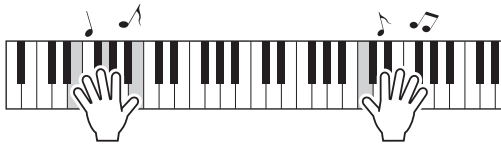

5 Turn off the power by pressing the [⏻] (Standby/On) switch for about a second.

The power gradually turns off.



CAUTION

Even after the power switch is turned off, electricity is still flowing to the instrument at the minimum level. Remove the electric plug from the outlet when the instrument is not to be used for extended periods of time, or during electrical storms.

Auto Power Off function

To prevent unnecessary power consumption, this instrument features an Auto Power Off function that automatically turns the power off if the instrument is not operated for a specified period of time. The amount of time that elapses before the power is automatically turned off is approximately 30 minutes by default; however, you can change the setting (page 88).

NOTICE

- Any data which are not saved will be lost if the power automatically turns off. Make sure to save your data before this happens.
- Depending on the instrument status, the power may not turn off automatically, even after the specified period of time elapses. Always turn off the power manually when the instrument is not in use.

Disabling Auto Power Off (simple method)

Turn the power on while holding down the lowest key on the keyboard. An “Auto power off disabled” message appears briefly and Auto Power Off is disabled.

The lowest key (A-1)

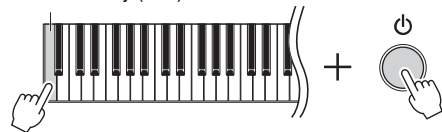

Adjusting the Master Volume

To adjust the volume level by using the [MASTER VOLUME] control located at the front left, just below the keyboard while playing the keyboard.



CAUTION

Do not use this instrument at a high volume level for a long period of time, or your hearing may be damaged.

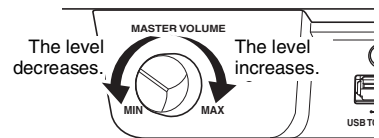

Intelligent Acoustic Control (IAC)

IAC is a function which automatically adjusts and controls the sound quality according to the overall volume of the instrument. IAC Control is effective only on the sound output of the instrument speakers or headphones. Even when the volume is low, this lets you hear both low sounds and high sounds clearly. Especially when using the headphones, the burden on the ears is reduced without raising the overall volume excessively.

You can set the IAC setting On or Off and its depth. For details, refer to “IAC” and “IAC depth” on page 86. The default setting for this function is “On.”

Using Headphones

Connect a pair of headphones to one of the [PHONES] jacks. Since this instrument is equipped with two [PHONES] jacks, you can connect two pairs of headphones. If you are using only one pair, insert the plug into either of these jacks.



CAUTION

Do not use the headphones for a long period of time at a high or uncomfortable volume level, since this can cause permanent hearing loss.

NOTE

- By default, when the headphones are plugged into either of the [PHONES] jacks, the internal speaker system is automatically shut off. If no sound is output from the speakers even though the headphones are disconnected, make sure that any conversion plugs are also disconnected from the [PHONES] jacks.
- You can also hear sound through the speakers with the headphones plugged in. For details, refer to “Speaker” on page 88.

If you attach the included headphone hanger, you can hang the headphones on the main unit. Attach with two screws as shown.

NOTICE

Do not hang anything other than the headphones on the hanger. Otherwise, the instrument or the hanger may be damaged.

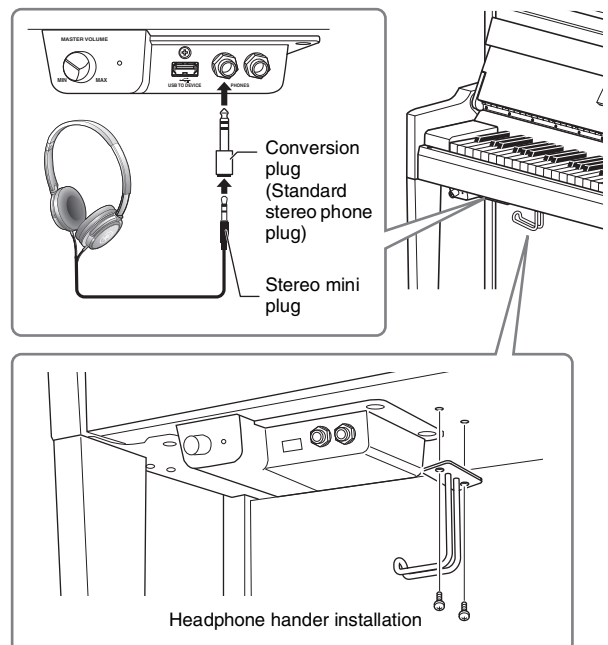

Reproducing the Natural Sensation of Sound Distance —Binaural Sampling and Stereophonic Optimizer

This instrument features two advanced technologies that allow you to enjoy exceptionally realistic, natural piano sound, even when listening on headphones.

• Binaural Sampling

Binaural sampling is a method that uses two special microphones set at the ear position of a performer and records the sound from a piano as it is. Listening to the sound with this effect through headphones gives the impression of being immersed in the sound, as if it was actually emanating from the piano. When “CFX Grand” or “Bösendorfer” (page 22) is selected, connecting the headphones automatically enables binaural sampling sound.

Sampling

A technology which records the sounds of an acoustic instrument then stores them to the tone generator to be played based on information received from the keyboard.

• Stereophonic Optimizer

The Stereophonic Optimizer is an effect which reproduces natural sound distance like the sound of binaural sampling even though you hear it on headphones. When any other Voice in the Piano group besides “CFX Grand” or “Bösendorfer” is selected, connecting the headphones automatically enables the Stereophonic Optimizer.

NOTE

Voices in the Piano group are those contained in the “Piano” category in the Voice List (page 94). For details about selecting Voices, refer to page 26.

This function is turned on by default. Note that when the “Speaker” setting (page 88) is “On,” this function will always be disabled. Since these sounds are optimized for listening with headphones, we recommend that you set this function to “Off” in the following situations.

- Playing the piano sound of this instrument with an external powered speaker system, while monitoring the sound output from this instrument on connected headphones.
- Making an audio recording (page 52) while using headphones, and then playing that recorded audio Song through speakers of this instrument. (Make sure to turn off these functions before audio recording.)

For details on setting this On or Off, refer to “Binaural” on page 86.

NOTE

Before connecting an external powered speaker system, be sure to read “Connecting to Other Devices” (page 62).

Using the Pedals

This instrument is equipped with three pedals. Before using, turn the adjuster to make sure the pedals fit snugly to the floor and do not wobble when the pedals are depressed.

NOTICE

When moving the instrument, rotate the adjuster to keep it off the floor. Failing to do so may cause damage to the floor.

NOTE

The pedals are protected with vinyl covers when shipped from the factory. Remove the covers from the pedals before using to ensure optimum use of the pedal effects.

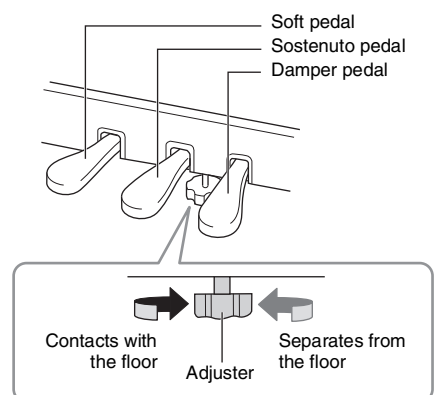

Damper pedal (right pedal)

When you press the damper pedal, the notes you play have a longer sustain. When you select a Voice in the Piano group, pressing the damper pedal activates the VRM (page 25) to accurately recreate the unique resonance of an acoustic grand piano's soundboard and strings.

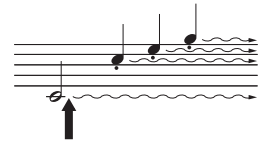

When you press the damper pedal here, the notes you play before you release the pedal have a longer sustain.

GP Response Damper

The damper pedal of this instrument has been designed to provide enhanced tactile response and, when pressed, is much closer in feel to the pedal of an actual grand piano. It makes it easier to physically experience the half-pedal point and more easily apply the half-pedal effect than other pedals.

NOTE

- Voices in the Piano group are those contained in the "Piano" category in the Voice List (page 94). For details about selecting Voices, refer to page 26.
- You can assign other functions to each pedal by using "Pedal Assign" in "Voice" menu (page 79).

Half-pedal function

The damper pedal also has a Half-pedal function which allows you to use half-damper techniques, in which the damper is pressed somewhere between all the way down and all the way up. In this half-damper state (on a real piano), the damper felts only partially mute the strings. This function lets you delicately and expressively control the damper muting, and create subtle nuances in your performance, by finely controlling the point at which pressure on the pedal affects the damper muting. For details on setting this, refer to "Half Pedal Point" on page 25.

Sostenuto pedal (center pedal)

If you play a note or chord on the keyboard and press the sostenuto pedal while holding the note(s), the notes will sustain as long as the pedal is held. All subsequent notes will not sustain.

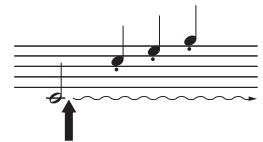

When you press the sostenuto pedal here while holding the note(s), the notes will sustain as long as you hold the pedal.

NOTE

- While the sostenuto (center) pedal is held, a sustained (nondecaying) type of Voice such as strings or organ may sound continuously without decay after the notes have been released.
- The center pedal or left pedal can also be used as a [PLAY/PAUSE] button. For details on the settings, refer to "Play/Pause" on page 86.

Soft pedal (left pedal)

The soft pedal reduces the volume and slightly changes the timbre of notes played while the pedal is pressed. The soft pedal will not affect notes that are already playing when it is pressed. In order to apply this effect, play notes after pressing the pedal.

Keep in mind that this pedal may control a function other than the Soft pedal, depending on the selected Voice (page 79). When "Jazz Organ" is selected, this pedal switches the Rotary Speaker speed between slow and fast ("Rotary Speed" on page 78). When "Vibraphone" is selected, this pedal switches Vibrato on and off ("VibeRotor" on page 78).

Basic Operations

On the screen display, you can call up three main functions: Voice, Song and Demo. In addition, various detailed settings can be made, for even greater playability and performance potential.

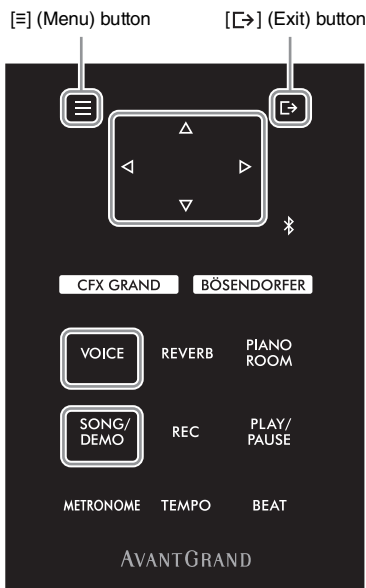

Selecting Voices

1. Press the [VOICE] button to call up the Voice group list.



2. Press the [Δ] or [▽] button to select a Voice group.



Selecting Songs and Demos

1. Press the [SONG/ DEMO] button to call up the Song category list.



2. Press the [Δ] or [▽] button to select a Song category.

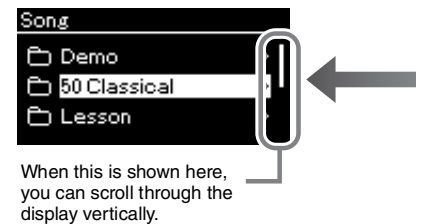

Resetting to the Default Setting

If you want to reset the selected value to its default setting, press and hold the [≡] (Menu) button.

Detailed Settings (Menu display)

1. Press the [≡] (Menu) button repeatedly to select the desired menu.

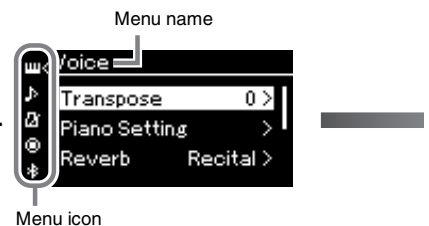

Changing the Control Panel Settings

You can change the time that elapses until the control panel turns off, or you can set it to remain on indefinitely. You can also set the operation sound to off. For details, refer to "Auto Backlight Off" or "Touch Panel Sound" on page 89.

NOTICE

Do not operate the control panel using a sharp item, your fingernails or other hard objects. This may damage the control panel.

Voice: Instrument sound for playing from the keyboard. In addition to the Piano sounds, a wide variety of other musical instrument sounds are available.

Song: A piece of music for listening enjoyment or for playing back and practicing along with.

Demo: Voice Demos let you experience the characteristics of the Voices.

3. Press the [Δ] or [∇] button to select a Voice.

[▷] to select a Voice.
[◀] to return.

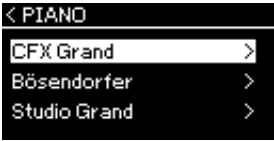

[▷] to select a Voice.
[Δ] to return.

4. Play the keyboard.

Voice display



This indicates the current position in the Voice group.

Press the [◀] or [▷] button to select the previous or next Voice.

3. Press the [Δ] or [∇] button to select a Song.

[▷] to select a Song.
[◀] to return.

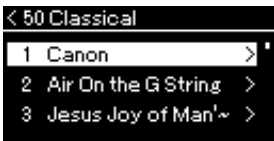

When "Lesson" is selected, press the [Δ] or [∇] button to select a Lesson type.

[▷] to select a Song.
[Δ] to return.

4. Press the [PLAY/PAUSE] button to playback the Song.

Song display

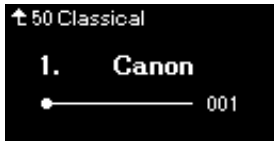

Use the [◀] or [▷] button to select the previous or next bars.

2. Press the [Δ] or [∇] button to select a parameter.

[▷] to detailed settings.
[◀] to return.



Note that the hierarchy depth differs depending on the selected parameter.

[▷] to detailed settings.
[◀] to return.

Adjusting the value on the slider pop-up window



3. Press the [◀] or [▷] button to adjust the value, press the [↵] (Exit) button to close the pop-up window.

Return to the Voice/Song display



Press the [↵] (Exit) button to return to the Voice display or the Song display, depending on which display was previously shown. While the pop-up window is shown, pressing the [↵] (Exit) button returns to the previously shown display.

Selecting a value from a list



A checkmark is shown at the right of the selection.

3. Use the [Δ][∇] buttons or the [▷] button to select a setting.

Press the [◀] button to return to the previous display.

Enjoying the Piano Performance

This instrument puts the sounds of two renowned grand pianos, the Yamaha CFX and Bösendorfer Imperial, as well as other piano sounds—each with its own distinctive appeal and sonic characteristics. Simply select the particular piano sound desired, according to the music you intend to play or your personal preferences.

Selecting two Grand Piano Voices from the panel directly



- 1 Press the [CFX GRAND] button or the [BÖSENDORFER] button to select the piano type.

A Voice is called up from the selected Voice button and its name appears on the Voice display.

Voice display



CFX Grand

Yamaha's CFX concert grand piano sound with a wide dynamic range for maximum expressive control. Suitable for playing in any music genre and style.

Bösendorfer

The famed sound of the Vienna-made Bösendorfer Imperial concert grand piano. Its spacious sound evokes the size of the instrument, and is ideal for expressing tenderness in compositions.

- 2 Play the Keyboard.

Selecting Other Piano Voices

Press the [◀]/[▶] buttons to select other piano Voices than "CFX Grand" and "Bösendorfer." You can also select the other Voices by pressing the [VOICE] button (page 26).

NOTE

You can hear and experience the characteristics of the Voices by listening to the Demo Songs for each Voice (page 28).

Customizing the Sound and the Touch Sensitivity of Piano Voices (Piano Room)

You can adjust the detailed settings of Voices in the Piano group in the Piano Room. Try creating a custom piano sound by adjusting the various parameters such as lid position, string resonance, damper resonance and so on.

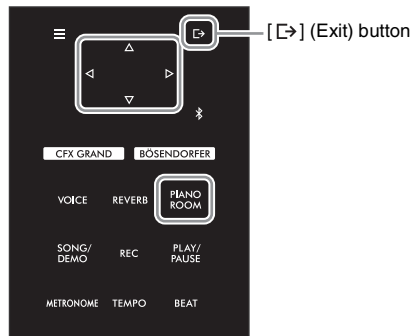

NOTE

Voices in the Piano group are those contained in the "Piano" group in the Voice List on page 94.

- 1 Press the [PIANO ROOM] button to call up the Piano Room display.

Piano Room display















NOTE

- If a Voice other than one in the Piano group is selected, pressing the [PIANO ROOM] button changes it to "CFX Grand."
- Pressing the [PIANO ROOM] button disables the Duo function (page 32).

- 2 Press the [Δ]/[∇] buttons to select items (page 24).
- 3 Press the [\leftarrow]/[\rightarrow] buttons to change the settings (page 24).
- 4 Press the [Exit] (Exit) button to exit from the Piano Room display.

Parameters you can set in the Piano Room

Item	Icon	Description	Default setting	Setting Range		
Lid Position		Recreates the differences in sound depending on how high the (virtual) grand piano lid is opened.	Full	Full, Half, Closed		
Brightness		Adjusts the brilliance of sound.	Differs depending on the Voice.	0 – 10		
Touch		Determines how the sound responds to your playing strength. You should adjust this setting according to the specific Voice you're playing or the particular Song you're performing, as desired.	Medium	Soft2, Soft1, Medium, Hard1, Hard2, Fixed		
Reverb		Determines the Reverb type which is applied to all the entire sound including the keyboard performance, Song playback and MIDI data input from an external MIDI device.	Differs depending on the Voice.	Refer to the Reverb Type List (page 29)		
		Reverb Depth	Adjusts the Reverb depth. When "Reverb" is set to "off" or a value of "0," no effect is produced.	Differs depending on the Voice.	0 – 40	
Master Tune		Fine tunes the pitch of the entire instrument. This function is useful when you play this instrument along with other instruments or CD music.	A3 = 440.0 Hz	A3 = 414.8 Hz – 466.8 Hz (approx. 0.2 Hz steps)		
VRM		Turns the VRM effect on/off. For information about the VRM function, refer to page 25. Listening to the VRM Demo Press the [PLAY/PAUSE] button while this display is open to play back the VRM Demo Song. You can hear the Demo Song with and without the effect (VRM on or off). 	On	On, Off		
		Damper Resonance	Determines the depth of the string resonance effect which is applied when the damper pedal is pressed.	5	0 – 10	
		Damper Noise		Turns the Damper Noise produced by the VRM function On/Off. For details on damper noise, refer to page 25. This function will be disabled when "Damper Resonance" is set to "0."	On	On, Off
		String Resonance	Determines the depth of the string resonance effect which is applied when a note on the keyboard is pressed.	5	0 – 10	
		Duplex Scale Resonance		Adjusts the sympathetic vibrations of the duplex scaling resonance effect in VRM. For details about duplex scaling, refer to "What is Duplex Scale?" (page 25).	5	0 – 10
		Body Resonance	Adjusts the resonance of the piano itself (the soundboard, the sides, the frame and so on) in VRM.	5	0 – 10	

Item	Icon	Description	Default setting	Setting Range
Grand Expression		<p>Selects the type of the Grand Expression Modeling effects, which simulates the physical sound transitions of an actual piano. When this feature is set to "Dynamic," you can control extremely subtle nuances in the performance and sound by changing your playing strength or touch. When set to "Static," the nuances are generally fixed. For details about Grand Expression Modeling, refer to the below.</p> <p>NOTE Grand Expression Modeling is effective only for the Voices of "CFX Grand" and "Bösendorfer."</p> <p>Listening to the Demo Press the [PLAY/PAUSE] button while this display is open to play back the Demo Song of this function. You can listen to the Demo song with "Dynamic" or "Static."</p> 	Dynamic	Dynamic, Static
Half Pedal Point		<p>Specify the point to which you must depress the right pedal before the effect of "Sustain Continuously" begins to be applied. This setting applies only to the "Sustain Continuously" effect (page 80) that is assigned to the right pedal.</p>	0	-2 (effective with the shallowest press) - 0 - +4 (effective with the deepest press)

NOTE

- If you wish to keep the Piano Room settings even after turning off the power, set "Voice" and "Other" in the "Backup" setting to "On." For details, refer to page 92.
- The items listed above can also be set in the "Voice" menu (page 77) or the "System" menu (page 85). When you change these settings in the Piano Room display, the settings in the menu displays will also be changed. Conversely, changing the settings in the menu displays will also change the settings in the Piano Room display.
- To restore the default value, press and hold the [=] (Menu) button while the setting value is shown.

What is VRM?

The VRM (Virtual Resonance Modeling) function uses sophisticated physical modeling to simulate the actual string resonance sound that occurs when the damper pedal on a real piano is pressed or keys are played and held. On an actual acoustic piano, if you press the damper pedal and play a key, not only does the string of the pressed key vibrate, it also causes other strings and the soundboard to vibrate, each influencing the rest and creating a rich and brilliant resonance that sustains and spreads. The VRM (Virtual Resonance Modeling) technology featured in this instrument reproduces the complicated interaction of both string and soundboard resonance faithfully using a virtual musical instrument (physical modeling), and makes the sound more like a real acoustic piano. Since instantaneous resonance is made at the moment according to the state of the keyboard or pedal, you can vary the sound expressively by changing the timing of your pressing the keys, and the timing and depth of your pressing the pedal.

What is Duplex Scale?

Duplex scaling is a stringing method for pianos that uses extra, un-struck strings in the upper octaves to enhance the tone. These strings sympathetically vibrate with other strings in an acoustic piano, resonating with overtones, and adding richness, brilliance and complex color to the sound. Since they do not have a damper, they will continue sounding even after you release your hands from the keyboard.

What is Damper Noise?

Damper noise is the sound made on an acoustic piano when the damper pedal is pressed. The damper noise changes in tone and volume depending on how quickly the damper pedal is pressed down. Pressing the damper pedal slowly will make a quieter sound when the damper heads are released from the strings. Pressing the damper pedal with force will transmit the vibrations to the strings, which adds a lower and louder sound.

What is Grand Expression Modeling?

On an actual acoustic piano, subtle changes in the sound can be produced by changing your playing touch from when you press a key to when you release it. For example, when you press a key all the way to its bottom, the key hits the keybed underneath and the noise reaches the strings, changing the sound slightly. Furthermore, the tone when the damper is lowered onto strings to mute the sound is changed by how quickly you release the key. The Grand Expression Modeling technology recreates these subtle changes in the sound that respond to your touch. This allows you to add accents by playing strongly or add resonance by playing softly to produce superbly expressive sound. A crisp tone can be heard when playing staccato as well as a lingering sound produced when releasing the keys slowly.

Playing Various Musical Instrument Sounds (Voices)

In addition to the wonderfully realistic piano sounds, you can select and play other musical instrument sounds (Voices), such as organ or stringed instruments. You can also select authentic Voices of fortepianos, which were made in 18th and 19th centuries.

Selecting Voices

The Voices of the instrument are conveniently divided into groups of instrument types. Select a desired Voice and play the keyboard.

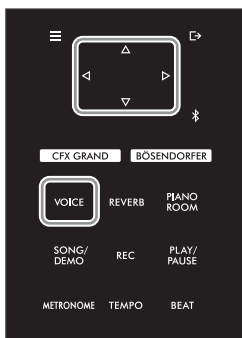

NOTE

- To hear and experience the characteristics of the Voices, listen to the Demo Songs for each Voice (page 28).
- Touch Sensitivity will not be applied to some Voices. For information about the Voices to which Touch Sensitivity can be applied, refer to the Voice List on page 94.

1 Press the [VOICE] button to call up the Voice group list.

The currently selected Voice group is highlighted.

Voice group list



Voice group

NOTE

For information about the Voices, refer to the Voice List on page 94.

2 Use the [Δ]/[▽] buttons to select the Voice group.

Highlight the Voice group name you want to use.

3 Press the [▷] button.

The Voices in the selected group are listed in the display.



Voice

NOTE

Press the [◀] button to return to the Voice list for selecting the Voice group.

4 Use the [△]/[▽] buttons to scroll through the Voice list, and then press the [▶] button to select the desired Voice.

The currently selected Voice name is shown in the display.

Voice display



You can select other Voices in order using the [◀][▶] buttons via the Voice display.

Press the [△] button to go back to the Voice group list.

5 Play the keyboard.

NOTE

You can specify the Touch Sensitivity (how the sound responds to the way you play the keys). You should adjust this setting according to the specific Voice you're playing or the particular Song you're performing, as desired. For details on the settings, refer to "Touch" on page 85. You can also adjust the Touch Sensitivity for the Voices in the Piano group from the Piano Room display (page 24).

Listening to the Voice Demos

Several Demo recordings have been specially prepared to showcase the exceptional characteristics of the corresponding Voices. For information about the Voices that can be heard with these Demos, refer to the “Voice Demo Song List” on page 96.

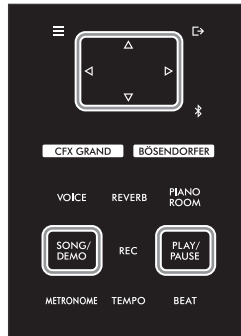

- 1 Press the [SONG/DEMO] button to call up the Song category list.

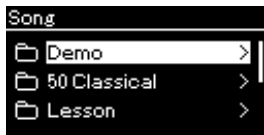

- 2 Use the [Δ]/[▽] buttons to select “Demo,” and then press the [▷] button.
- 3 Use the [Δ]/[▽] buttons to select the desired Voice Demo, and then press the [▷] button to call up the Demo display.

The currently selected Voice Demo name is shown in the display.

Demo display



- 4 Press the [PLAY/PAUSE] button to start playback.
- 5 Press the [PLAY/PAUSE] button again to stop playback.

The Voice Demo stops automatically when Voice Demo playback reaches the end.

Selecting Other Demos

Press the [Δ] button to return to the Song category list, then repeat steps 3 – 4 of this section.

NOTE

Recording operations cannot be used during Voice Demo playback.

Enhancing and Customizing the Sound

Applying the following effects gives you greater and richer expressive capabilities.

Adding reverberation to the sound (Reverb)

Adds reverberation to the sound. You can enjoy the realistic feeling of playing in a concert hall. When you select a Voice, the optimum Reverb Type is automatically selected, but you can also select it yourself. The Reverb type selected here is applied to the entire sound, including the keyboard performance, Song playback and MIDI data input from an external device.

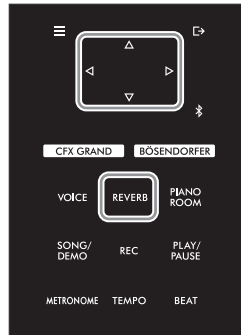

1 Press the [REVERB] button to call up the “Reverb” display.

“Reverb” display

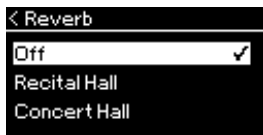

The Reverb type for the Voices in the Piano group can also be set in the Piano Room display (page 24).

2 Use the [Δ]/[▽] buttons to select the Reverb type.

■ Reverb Type List

Off	No effect
Recital Hall	Simulates clear reverberation in a mid-sized hall suitable for piano recital.
Concert Hall	Simulates brilliant reverberation in a large hall for public orchestra performances.
Chamber	Simulates the elegant reverberation in a small room suitable for chamber music.
Cathedral	Simulates the solemn reverberation in a high-ceiling stone-made cathedral.
Club	Simulates the lively reverberation in a jazz club or a small bar.
Plate	Simulates the bright sound of vintage reverb equipment used in recording studios.

NOTE

You can adjust the Reverb depth for the selected Voice from the “Voice” menu: “Voice Edit” → “Reverb Depth” (page 78).

Adjusting the brightness of the sound (Brilliance)

For adjusting the brightness of the sound or creating your own custom EQ settings. These settings are applied to the entire sound, including the keyboard performance, Song playback and MIDI data input from an external device.

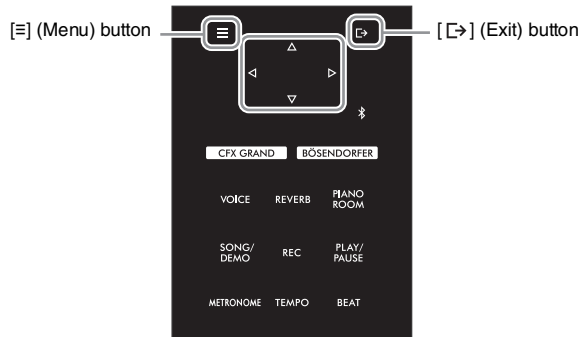

- 1 Press the [Menu] button repeatedly to call up the “System” menu display, then select the highlighted item in each display as illustrated below.

“System” menu display

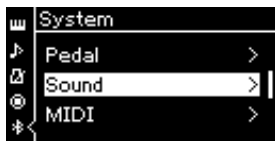

- 1-1. Use the [Δ]/[∇] buttons to select “Sound.”
- 1-2. Press the [▷] button to call up the next display.

“Sound” display



- 1-3. Use the [Δ]/[∇] buttons to select “Brilliance.”
- 1-4. Press the [▷] button to call up the next display.

“Brilliance” display



- 1-5. Use the [Δ]/[∇] buttons to select the value.

Use the [Δ]/[∇] buttons to select the desired tonality in the “Brilliance” display. To reset the default setting, hold down the [Menu] button.

Mellow 1–3	Soft and mellow tone. The sound becomes more mellow and warmer as the number increases.
Normal	Standard tone.
Bright 1–3	Bright tone. The sound becomes brighter as the number increases.
User	Opens the “User” display, where you can create your own custom EQ settings. For details, refer to page 31.

Default setting: Normal

NOTE

If you select Bright 1–3 for the Brilliance setting, the volume level will increase slightly. In this condition, if you raise the [MASTER VOLUME] control setting, the sound may become distorted. If this happens, lower the volume accordingly.

- 2 Press the [Exit] button to close the “Brilliance” display.

Setting the User EQ

In the “Brilliance” display, you can also create your own custom EQ settings. The EQ (Equalizer) processes the sound by dividing the frequency spectrum into multiple bands, allowing you to boost or cut them as required to tailor the overall frequency response and provide optimum sound when listening through the instrument’s internal speaker or headphones, etc.

The User EQ setting is applied to the entire sound including the keyboard performance, Song playback and MIDI data input from an external device.

- 1 **Select “User” in the “Brilliance” display (step 1-5 on page 30), and then press the [▷] button.**

A display in which you can set the gain for three frequency bands appears.

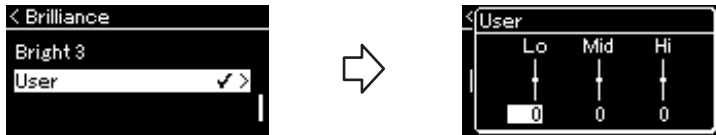

- 2 **Use the [◀]/[▶] buttons to select a band, then use [△]/[▽] buttons to boost or cut it.**

To reset the gain for each frequency band to the default value, hold down the [≡] (Menu) button.



Default setting: 0 dB

Setting range: -6 dB – 0 – +6 dB

- 3 **Press the [↵] (Exit) button to close the “User” display.**

Adding Chorus effect to the sound

This control adds warmth and spaciousness to the sound. The ideal Chorus type is automatically selected whenever you select a Voice, but you can select any of the available Chorus types. To select a desired Chorus type, use the “Voice” menu: “Chorus” (page 77). This setting is applied to the entire sound, including the keyboard performance, Song playback and MIDI data input from an external device.

NOTE

- You can adjust the Chorus depth for the selected Voice from the “Voice” menu: “Voice Edit” → “Chorus Depth” (page 78).
- When you want to apply the Chorus effect to a Voice whose Chorus type is set to off by default, set the Chorus type to something other than “Off,” then set the Chorus depth value as desired (greater than “0”).

Applying Effects

This instrument features a wide variety of Effects, letting you apply enhancements such as Echo or Tremolo to the selected Voice for your keyboard performance. You can select any of the available Effect types from the “Voice” menu: “Voice Edit” → “Effect” (page 78).

Playing Duo

This function allows two different players to play the instrument, one on the left and the other on the right. This is convenient for practicing duets over the same octave range.

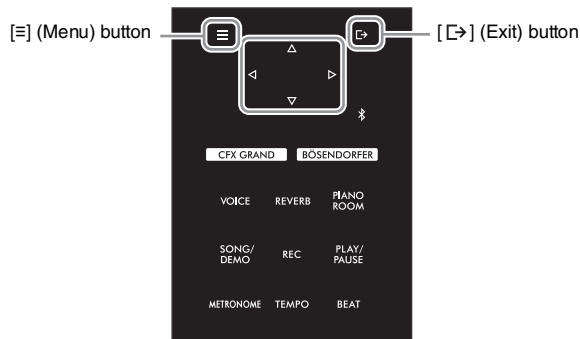

1 Press the [≡] (Menu) button repeatedly to call up the “System” menu display, and then select the highlighted item in each display as illustrated below.

“System” menu display

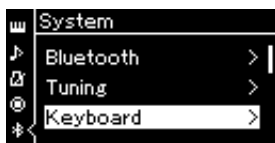

“Keyboard” display



- 1-1. Use the [Δ]/[▽] buttons to select “Keyboard.”
- 1-2. Press the [▷] button to call up the next display

- 1-3. Use the [Δ]/[▽] buttons to select “Duo.”
- 1-4. Press the [▷] button to select “On.”

The keyboard is divided into two sections, with the E3 key as the Split Point.

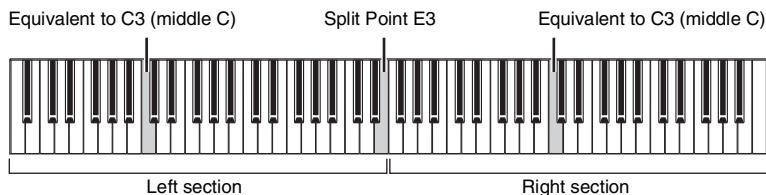

The pedal function changes as follows.

Right Pedal	Damper pedal for the Right section
Center Pedal	Damper pedal for both the Right and Left sections
Left Pedal	Damper pedal for the Left section

NOTE

- In Duo, VRM (page 24) is not effective. When the Duo Type (page 86) is set to “Separated,” Reverb (page 29) and Binaural Sampling (page 86) are not effective.
- The specified Split Point key is included in the Left section.

2 Press the [↵] (Exit) button to call up the Voice display.

[Duo] is shown in the Voice display while Duo mode is on.

If necessary, use the [◀]/[▶] buttons or the [VOICE] button to select the desired Voice. Only one Voice can be selected for the Right and Left sections.



3 Play the keyboard.

The sound of Left section is emitted from the left, the sound of Right section is emitted from the right by default.

4 To turn Duo off, press the [CFX GRAND], [BÖSENDORFER] or [PIANO ROOM] button.

You can also turn it off by selecting "Off" on the display in step 1.

NOTE

You can listen to the sounds played by two players through both speakers as well, with a natural balance of sound. Press the [≡] (Menu) button repeatedly to call up the "System" menu, and then change the setting in "Keyboard" → "Duo-Type" (page 86).

Using the Metronome

The instrument has a built-in metronome (a device that keeps an accurate tempo)—a convenient tool for practice.

1 Press the [METRONOME] button to start the metronome.

This calls up the Tempo display, from which you can adjust the tempo. For details, see next section.

2 Press the [METRONOME] button to stop the metronome.

To close the Tempo display, press the [↵] (Exit) button.

NOTE

- For information on setting the time signature, refer to page 35.
- You can set the metronome volume, BPM and so on from the Metronome menu (page 84).

Adjusting the Tempo

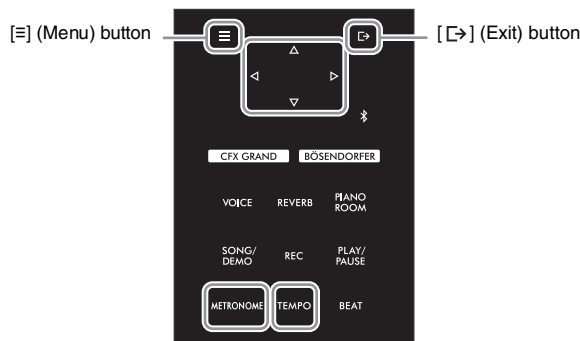

1 Press the [TEMPO] button to call up the Tempo display.



2 Use the [◀]/[▶] buttons to adjust the tempo value (number of beats per minute).

To reset tempo to the default setting

Hold down the [≡] (Menu) button.

3 Press the [↵] (Exit) button to close the Tempo display.

NOTE

When you select a Song, the metronome tempo changes to the tempo of the Song. The metronome tempo is reset to the default setting (120) when the power is turned off.

Setting the Metronome Time Signature

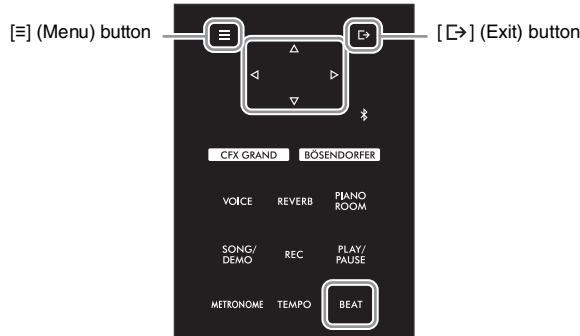

1 Press the [BEAT] button to call up the “Time Sig.” display.

“Time Sig.” display



2 Use the [Δ]/[∇] buttons to select the desired time signature.

Setting range: 2/2, 3/2, 1/4, 2/4, 3/4, 4/4, 5/4, 6/4, 7/4, 3/8, 6/8, 7/8, 9/8, 12/8

Default setting: 4/4 (Selecting a MIDI Song will change the time signature to that specified in the selected MIDI Song data.)

Tempo indication and Setting range

Tempo is displayed as “note type=xxx” (For example: $\text{♩}=120$). Selecting the Time Signature changes the available parameters as follows.

Note type	Time Signature	Setting range
♩ Half note	2/2, 3/2	3 – 250
♩ Quarter note	1/4, 2/4, 3/4, 4/4, 5/4, 6/4, 7/4	5 – 500
♩. Dotted quarter note	6/8, 9/8, 12/8	4 – 332 (even numbers only)
♩ Eighth note	3/8, 7/8	10 – 998 (even numbers only) and 999

* When the tempo value of the selected MIDI Song is outside the setting range on the instrument, the value will be changed to fit within the setting range.

* Note type will be fixed to quarter note as long as the “BPM” parameter in the “Metronome” menu (page 84) is set to “Crotchet” regardless of the Time Signature you set.

Note type

The length of one beat

Metronome detailed settings

You can set the metronome volume, BPM and so on from the “Metronome” menu (page 84).

3 Turn the “Bell” setting on.

For details, refer to “Bell” in the “Metronome” menu (page 84).

The Metronome plays back according to the selected Time Signature with the Bell sound on the first beat of each measure.

4 Press the [Exit] button to close the “Metronome” menu.

Playing Back Songs

This instrument can play Preset Songs, Songs you recorded on this instrument, or commercially available Songs. In addition to listening to these Songs, you can play the keyboard as the Song plays back. There are two kinds of Songs that can be recorded and played back on this instrument: MIDI Songs and Audio Songs.

• MIDI Song

MIDI

A MIDI Song is comprised of your keyboard performance information and is not a recording of the actual sound itself. The performance information refers to which keys are played, at what timing, and at what strength—just as in a musical score. Based on the recorded performance information, the tone generator outputs the corresponding sound. A MIDI Song uses a small amount of data capacity in comparison to an Audio song, and allows you to easily change aspects of the sound, such as Voices used, etc.

• Audio Song

Audio

An Audio Song is a recording of the performed sound itself. This data is recorded in the same way as that used with voice recorders, etc. This data can be played with a portable music player, etc., allowing you to easily let other people hear your performance.

Availability of functions differs between MIDI Songs and Audio Songs. In this chapter, the following icons indicate whether or not the explanation applies to MIDI Songs or Audio Songs individually.

Example:

MIDI

Audio

Indicates explanation applies only to MIDI Songs.

You can play back the following types of Songs in this instrument.

- Voice Demo Songs (Voice Demo).
- Preset Songs: 50 classical Preset Songs (“50 Classical”) and 303 Lesson Songs (“Lesson”)
- Your own recorded Songs (see page 46 for instructions on recording)
- Commercially available MIDI Song data: SMF (Standard MIDI File)
The maximum size for playback on this instrument is approx. 500 KB per single MIDI Song.
- Commercially available Audio Song data: Wav (file extension = .wav with 44.1 kHz sample rate, 16-bit resolution, stereo, and maximum 80 minutes length)

Song Playback

MIDI | **Audio**

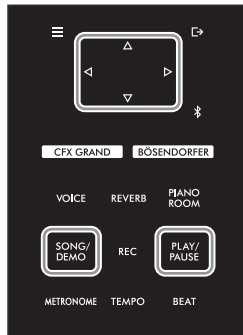

NOTE

The instrument can automatically select a Song file saved in the root directory of the USB flash drive as soon as the USB flash drive is connected. For instructions, refer to “USB Autoload” on page 88.

- 1 If you want to play back a Song in a USB flash drive, connect the USB flash drive containing Song data to the [USB TO DEVICE] terminal beforehand.
- 2 Press the [SONG/DEMO] button to call up the Song category list, then select the desired category using [Δ]/[▽] buttons.

NOTE

Before using a USB flash drive, be sure to read “Connecting USB Devices ([USB TO DEVICE] Terminal)” on page 64.

Select the desired one from “50 Classical,” “Lesson,” “User” or “USB” referring to the category descriptions below.

Song category list

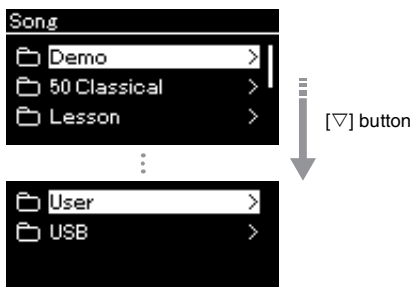

Demo	Voice Demos let you experience the characteristics of the Voices (MIDI Song). Refer to page 28 for how to play back the Demo. For Song names, refer to the “Voice Demo Song List” on page 96.
50 Classical	50 classical Preset Songs (MIDI Songs). For these Songs, see the music book “50 Classical Music Masterpieces,” included with this instrument. For details, refer to the “Song List” on page 97.
Lesson	303 Preset Songs (MIDI Songs) ideal for practice, taken from “The Virtuoso Pianist” and others. For these Songs, refer to the Lesson Songs on page 97. Lesson Songs are divided into several folders depending on the types.
User	MIDI Songs which have been recorded and saved to the instrument by using the recording function (page 46), and MIDI Songs which have been copied/moved to the instrument using File operations (page 57).
USB*	MIDI/Audio Songs saved to the USB flash drive by recording them with this instrument or Audio Songs converted from MIDI Songs (page 61), or MIDI/Audio Songs saved to the USB flash drive.

* This category appears only when a USB flash drive is connected to the [USB TO DEVICE] terminal.

3 Press the [▷] button to display the Songs in the specified category, and then select a desired Song using the [△]/[▽] buttons.

When “User” or “USB” category is selected, the icon indicating Song types are shown to the left of the Song name.

Song List

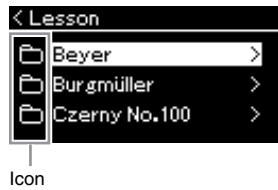

Icon	Data format
	Folder
	MIDI Songs
	Audio Songs

Since the Lesson Songs are conveniently divided into specific folders, select the desired folder, press the [▷] button, and then select a Song.

To select a recorded Song saved to USB flash drive:

When you record a Song and save it to a USB flash drive, the recorded Song will automatically be saved to the USER FILES folder on a USB flash drive. If you want to select the Song from the USER FILES folder, select USB in step 2, and USER FILES folder in step 3.

NOTE

Press the [◀] button to return to the category/folder.

NOTE

“NoSong” will be shown in the display when no data exists in that folder.

When Songs cannot be read from a USB flash drive

If the song cannot be read, you may need to change the Language setting for the Song name in the “System” menu (page 89).

4 Press the [▷] button to actually select the Song.

In the Song display, the currently selected Song name and its category name are shown.

Song display (MIDI Song)

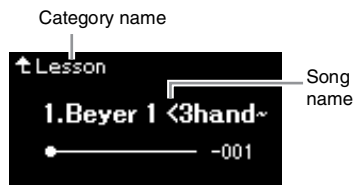

Song display (Audio Song)



NOTE

- Press the [△] button to return to the Song list.
- When the Song title is too long to be displayed, press the [▽] button to see the full title.

5 Press the [PLAY/PAUSE] button to start playback.

The current position of the Song playback will be shown.

Song display (MIDI Song)



Song display (Audio Song)

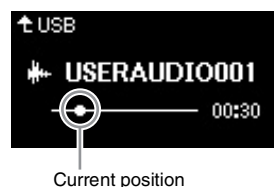

You can play the keyboard along with Song playback. You can also change the Voice for your keyboard performance. To adjust the volume balance between your keyboard performance and MIDI Song playback, or to adjust the Audio Volume, set the appropriate Volume parameters individually in the “Song” menu (page 44).

NOTE

- If a Song has been selected, the original tempo of the Song is used, and the Metronome setting (page 34) will be ignored.
- Useful playback functions are described on pages 40 – 45.

6 Press the [PLAY/PAUSE] button again to stop playback.

Even if you don't press the [PLAY/PAUSE] button, the Song stops automatically when Song playback reaches the end.

Rewind/Fast forward/Returning to the top of the Song

- 1 Use the [◀] and [▶] buttons to move back or forth through the Song (in bars or seconds), while the Song display is shown.

Song display (MIDI Song)



Measure number

Song display (Audio Song)



Elapsed time

Holding the corresponding button scrolls backward/forward continuously.

Returning to the top of the Song

Hold down the [≡] (Menu) button.

Adjusting the tempo

You can adjust the playback tempo of a Song.

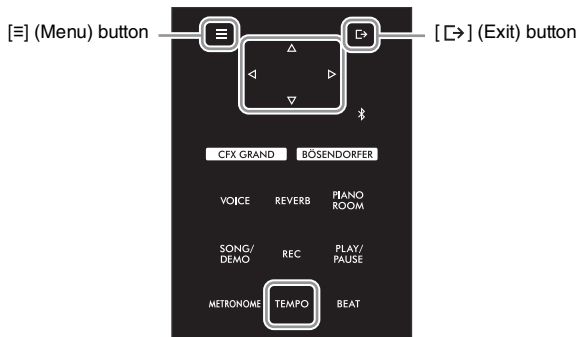

NOTE

Changing the tempo of an Audio Song may change its tonal characteristics.

- 1 Press the [TEMPO] button to call up the “Tempo” display.

For a MIDI Song, press the [TEMPO] button during Song playback or while the Song display is shown. For an Audio Song, press the [TEMPO] button during Song playback.

“Tempo” display (MIDI Song)

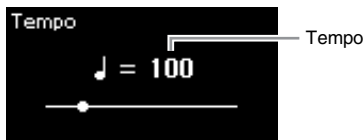

“Tempo” display (Audio Song)

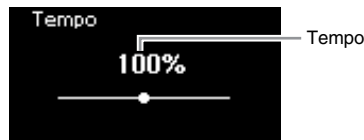

- 2 Change the Tempo value using the [◀]/[▶] buttons.

When a MIDI Song is selected, the tempo range differs depending on the Time Signature for a selected Song.

For MIDI Songs

The tempo range differs depending on the Time Signature for the selected MIDI Song. Available setting values may only include even numbers (multiples of 2), depending on the Time Signature. For more information, refer to page 35.

For Audio Songs

The tempo range is between 75% – 125%. 100% is the original tempo value. Higher values result in a faster tempo.

- 3 Press the [↵] (Exit) button close the “Tempo” display.

Playing a One-hand Part — Part Cancel Function (MIDI Songs)

MIDI Audio

Some MIDI Songs, such as Preset Songs, are divided into right-hand and lefthand parts. By using such Song data, you can practice the left hand by turning on only the right-hand part, and practice the right hand by turning on only the left-hand part—allowing you to practice parts separately for easy mastery of difficult material.

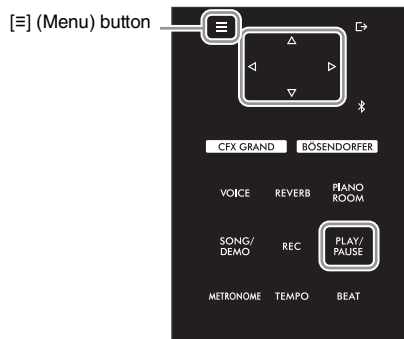

1 Select a Song for practicing.

For instructions, refer to page 37. Song categories “50 Classical” and “Lesson” are recommended for this.

2 Select a part you want to practice, then set the part to off.

Press the [≡] (Menu) button repeatedly to call up the “Song” menu display, then select the highlighted item in each display as illustrated below.

In the “L/R” display, select the part (track) you want to mute for practicing. Select “R” for practicing the right-hand part, or “L” for the left-hand part.

“Song” menu display

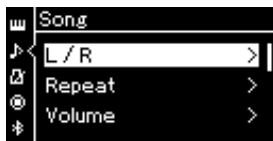

L/R display

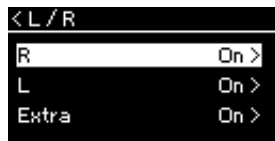

2-1. Use the [Δ]/[▽] buttons to select “L/R.”

2-2. Press the [▷] button to call up the next display.

2-3. Use the [Δ]/[▽] buttons to select desired part.

3 Use the [▷] button to select “Off” for the selected part.

4 Press the [PLAY/PAUSE] button to start playback.

Play and practice the part you just muted.

5 Press the [PLAY/PAUSE] button again to stop playback.

Even if you don’t press the [PLAY/PAUSE] button, the Song stops automatically when Song playback reaches the end.

NOTE

- The parts can be turned on or off even during playback.
- Usually, Channel 1 is assigned to “R,” Channel 2 is assigned to “L,” and Channels 3–16 are assigned to “Extra.” However, the assignments may differ depending on the particular Song. Channels assigned to “Extra” cannot be set to on or off individually.
- Some songs in “50 Classical” and “Lesson” categories are duet songs. Refer to page 97 about part assignment for the duet songs.
- Whenever you select another MIDI Song, both parts are automatically turned on.

NOTE

When the “Play Track” is set to “1&2,” tracks 3 to 16 are not played. For details, refer to page 82.

Playing Back a Song Repeatedly

MIDI | **Audio**

There are three Repeat methods as follows. These are convenient for repeatedly practicing difficult phrases. It is a good idea to use this function and the Part Cancel function (page 40) for practicing difficult phrases, in the case of MIDI Songs.

- **AB Repeat** Plays the specified range of the selected MIDI Song repeatedly.
- **Phrase Repeat** Plays a specific phrase of a MIDI Song containing Phrase Marks repeatedly.
- **Song Repeat** Plays a MIDI/Audio Song repeatedly, or plays all MIDI/Audio Songs saved in a selected category (folder) repeatedly either in order or in random order.

NOTE

Phrase Mark is a pre-programmed marker in certain MIDI Song data, which specifies a specific location in the Song.

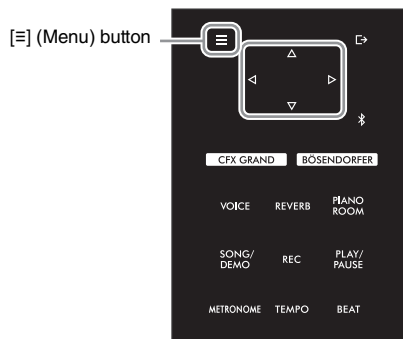

1 Select a Song to be played back.

For instructions, refer to page 37.

2 Call up the Repeat display.

Press the [≡] (Menu) button repeatedly to call up the “Song” menu display. Select “Repeat,” then press the [▷] button.

“Song” menu display

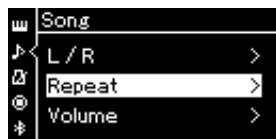

“Repeat” display

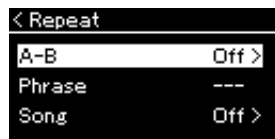

3 In the “Repeat” display, select a desired item using the [Δ]/[▽] buttons, then press the [▷] button.

Select “A–B” for AB Repeat, select “Phrase” for Phrase Repeat, or select “Song” for Song Repeat.

4 Set in the appropriate setting display.

- AB Repeat See page 42.
- Phrase Repeat..... See page 81 (“Phrase” section in “Repeat”).
- Song Repeat..... See page 43.

AB Repeat setting

MIDI Audio

See page 41 for information on basic operations. Continuing from step 4 on that page, follow the procedure below.

4-1 Press the [PLAY/PAUSE] button to start Song playback.

4-2 Press the [▷] button at the starting point (A) of the range to be repeated.

Setting display



4-3 Press the [▷] button again at the ending point (B).

After an automatic lead-in (to help guide you into the phrase), the range from Point A to Point B is played back repeatedly.

5 To turn off the Repeat function, press the [▷] button while "Repeat Off" is highlighted, or select another Song.



Specifying the top of a Song as Point A

Specify Point A before starting playback, then start playback and specify Point B.

Specifying the end of a Song as Point B

Specifying only Point A results in repeat playback between Point A and the Song end (as Point B).

NOTE

You can also specify the repeat range by the following procedure.

- 1 Highlight the measure number using the [△] button, then fast-forward the Song to Point A using the [◀]/[▶] buttons.
- 2 Highlight "Set A" using the [▽] button, then press the [▷] button.
After specifying Point A, the display for specifying Point B is called up.
- 3 Specify Point B in the same way as Point A.

Song Repeat setting

MIDI

Audio

See page 41 for information on basic operations. Continuing from step 4 on that page, follow the procedure below.

4-1 Select the desired Repeat type using the [Δ]/[∇] buttons in the setting display.

Setting display





Off	Disables Repeat playback. The Song stops automatically when playback of the selected Song reaches the end.
Single	Plays through the selected Song repeatedly.
All	Continuously plays back all Songs in the selected category or folder in order.
Random	Continuously plays back all Songs in the selected category or folder in random order.

4-2 Press the [PLAY/PAUSE] button to start Repeat playback.

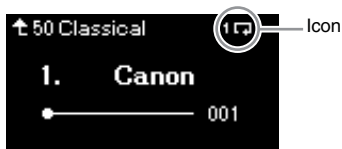
Icons corresponding to each Repeat setting are shown on the Song display.



While the Repeat setting is on,  (Single),  (All), or  (Random) is shown in the upper right corner of the Song display.

5 To turn off the Repeat function, press the [PLAY/PAUSE] button again to stop playback, and then select "Off" in step 4-1.

Adjusting the Volume Balance

MIDI | **Audio**

When a MIDI Song is selected, you can adjust the Volume balance between the Song playback and the sound you are playing on the keyboard, or between the Right and Left parts of the selected Song. When an Audio Song is selected, you can adjust the Audio Song volume.

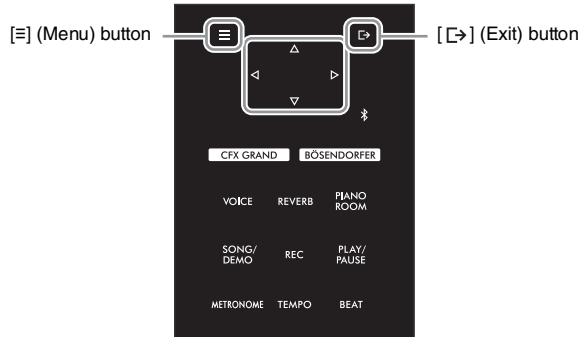

Select the desired Song beforehand. For instructions, refer to page 37.

- 1 Press the [≡] (Menu) button repeatedly to call up the “Song” menu display. Select “Volume,” and then press the [▷] button.

“Song” menu display (When a MIDI Song is selected)

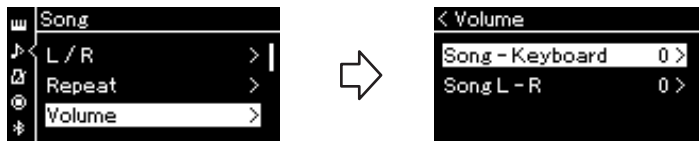

“Song” menu display (When an Audio Song is selected)

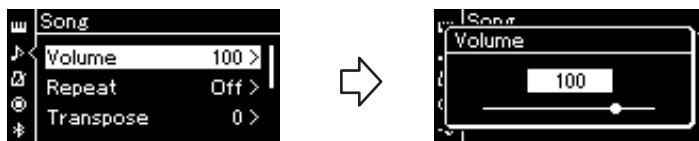

- 2 When a MIDI Song is selected, select “Song – Keyboard” or “Song L – R” using the [△]/[▽] buttons, then press the [▷] button to call up the setting display. When an Audio Song is selected, use the [◀]/[▶] buttons to set the Audio playback volume. After setting the value, go on to step 4.

NOTE

Some commercially available music data contain extremely high volumes. When using such data (MIDI Song), adjust the “Song – Keyboard” setting.

Song – Keyboard	Adjust the Volume balance between the MIDI Song playback and the sound you are playing on the keyboard.
Song L – R	Adjust the Volume balance between the Right and Left parts of the selected MIDI Song.

3 Adjust the Volume balance by using the [◀]/[▶] buttons.

In the case of “Song – Keyboard”:



← The volume of your playing will be lower. → The Song playback volume will be lower.

In the case of “Song L – R”:



← R part volume will be lower. → L part volume will be lower.

4 Press the [↵] (Exit) button twice to exit from the “Song” menu display.

Whenever you select another MIDI Song, the setting for “Song L – R” is restored to its default setting. As for “Song – Keyboard” and Audio Volume, selecting another Song will not reset the value.

NOTE

The selected parameters of “Song – Keyboard” will be maintained (Backup Setting) even when the power is turned off. Make sure not to set the volume levels to minimum. Otherwise the sound of keyboard or songs will not be played. You can change the settings to maintain the selected parameter or not. For details, refer to “Backup Setting” on page 92.

Useful Playback Functions

MIDI

Audio

Starting/pausing playback by using a pedal

You can assign the Song Play/Pause function (the same function as the [PLAY/PAUSE] button on the control panel) to the center or the left pedal. Press the [≡] (Menu) button repeatedly to call up the “System” menu, and then select “Pedal” → “Play/Pause” to make the assignment. For details, refer to page 86.

This is convenient for starting or pausing playback when you are performing and can't take your hands from the keyboard.

Transposing the pitch of a Song

You can shift the pitch of Song playback up or down in semitone intervals. Press the [≡] (Menu) button repeatedly to call up the “Song” menu → “Transpose.” For details, refer to page 81.

Recording Your Performance

This instrument allows you to record your performance in the following two methods.

- **MIDI Recording** **MIDI**

With this method, recorded performances are saved to the instrument or a USB flash drive as an SMF (format 0) MIDI file. If you want to re-record a specific section or edit parameters such as Voice, use this method. Also you can record your performance to each Track one by one. Since a MIDI Song can be converted to an Audio Song after recording (page 61), you may want to use MIDI recording (with overdubbing and multiple parts) to first create a complex arrangement you would not otherwise be able to play live, then convert it to an Audio Song. This instrument allows you to record approximately 500 KB of data per Song.

- **Audio Recording** **Audio**

With this method, recorded performances are saved to a USB flash drive as an Audio file. Recording is done without designating the recorded part. Since it is saved in stereo WAV format of normal CD quality resolution (44.1 kHz/16 bit), it can be transmitted to and played on portable music players by using a computer. Because the audio sound input* from the external device is also recorded, you can record your keyboard performance along with the performance sound of the connected audio device, computer, or smart device, etc. This instrument allows you to record up to 80 minutes per single recording.

* Audio sound input (Audio input sound): Audio data sent to this instrument from the external devices such as a computer or a smart device, etc., when connecting the instrument with the devices via [AUX IN] jack, USB [TO HOST] terminal, wireless LAN, or Bluetooth. For connection with these devices, refer to the "Connecting to Other Devices" section from page 62.

For details about the difference between MIDI Songs and Audio Songs, refer to page 36.

Recording Methods

This chapter covers the following four methods. Note that the created data format differs depending on the method, MIDI or Audio.

- **Quick MIDI Recording** **MIDI** (page 47)

This method lets you start recording most quickly. Your performance will be recorded and saved to the "User" category in this instrument's internal memory.

- **MIDI Recording — Independent Tracks** **MIDI** (page 49)

This lets you record the right, left and extra parts separately. Since you can record the left part while playing back the right, this is useful for recording both parts of a duet. Since you can record up to sixteen parts separately, record the performance of each instrument part one by one and create fully orchestrated compositions.

- **MIDI Recording to the USB Flash Drive** **MIDI** (page 51)

This method is useful when you want to overwrite the already recorded MIDI Song in the USB flash drive or create a New MIDI Song on the USB flash drive.

- **Audio Recording to the USB Flash Drive** **Audio** (page 52)

This method lets you record your performance as Audio data to the USB flash drive connected to the [USB TO DEVICE] terminal.

Quick MIDI Recording

MIDI

This is the quickest way to start recording.

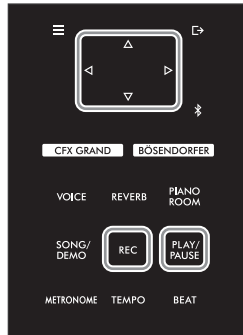

1 Make the necessary settings such as Voice selection and time signature.

Before starting the Recording operation, select a Voice (page 26) for your keyboard performance, turn Duo on or off as desired, set the tempo and time signature of the Metronome (page 34), then select a Reverb/Chorus/Effect type as desired.

2 Press the [REC] button to enter the Recording mode.

A blank new Song for recording is automatically set.

REC display



The [PLAY/PAUSE] button will flash at the current tempo.
To exit from the Recording mode, press the [REC] button again.

3 Play the keyboard (or press [PLAY/PAUSE]) to start recording.

When you wish to record an empty section at the start of the Song, press the [PLAY/PAUSE] button to start recording.

REC display (during recording)

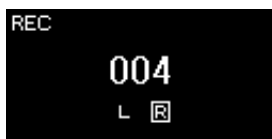

4 After you finish your performance, press the [REC] button again to stop recording.

This operation exits from the Recording mode and calls up the display for saving the recorded performance data.

NOTE

If you want to record the lefthand and right-hand parts individually, refer to “MIDI Recording—independent Tracks” (page 49) since the Recording method here assumes that both the left and right parts are being recorded together.

Using the Metronome

You can use the Metronome while recording. However, the Metronome sound cannot be recorded.

NOTE

- The “Song – Keyboard” Volume Balance (page 81) will not be recorded.
- With MIDI recording, the performance will be recorded to Track 1. However, in the Duo mode, the tracks assigned for recording and the tracks actually used for recording are different. For details refer to “Recording Track Assignment for Duo” on page 49.

Mode:

A mode is a status under which you can execute a certain function. In Recording mode, you can record Songs.

NOTE

Pressing and holding the [REC] button for a second will call up the display which lists the Recording Target Songs. In this case, select “New Song” then press the [▷] button referring to the table on page 51.

5 If you want to save the recorded performance, press the [▷] button to execute the Save operation while “Save” is highlighted.

After the Save operation is completed, the display shows “Save Completed” then returns to the Song display. The recorded Song will be named “USERSONGxxx” (xxx: number) and saved in the “User” category.



- If you are not satisfied with your performance and want to record again, highlight “Retry” then press the [▷] button. Try recording again from step 3.
- If you do not want to save the recorded data, highlight “Cancel” then press the [▷] button.

6 To hear the recorded performance, press the [PLAY/PAUSE] button.

NOTICE

The recorded MIDI Song will be lost if you change to another Song or you turn the power off without executing the Save operation.

Renaming the recorded Song

The recorded Songs are named automatically, but you can rename Songs as you like (page 61).

NOTE

Refer to page 59 for how to delete a Song.

Data that can be recorded to MIDI Songs

Data for each Track

- Note data (your keyboard performance)
- Voice selection
- Pedal operations (Damper/Soft/Sostenuto)
- Reverb Depth
- Chorus Depth
- Effect Depth
- Sound brightness — “Brightness”
- Resonance effect setting — “Harmonic Cont”
- Octave
- Volume setting for each Voice — “Volume”
- Pan for each Voice
- Touch Sensitivity — “Touch Sens.”
- Grand Expression Modeling data

Data commonly for all Tracks

- Scale
- Tempo
- Time Signature
- Reverb Type
- Chorus Type
- Effect Type

NOTE

Parameter settings other than Voice and Tempo, such as note data, pedal (Damper/Soft/Sostenuto) data, octave setting and time signature, cannot be changed after recording.

MIDI Recording — Independent Tracks

MIDI

With MIDI Recording, you can create a MIDI Song consisting of 16 tracks by recording your performance to each track one by one. In recording a piano piece, for example, you can record the right-hand part to Track 1 then record the left-hand part to Track 2, allowing you create a complete piece which may be difficult to play live with both hands together. In this way, you can create an entire Song which would otherwise be difficult, or even impossible, to play live.

Example:

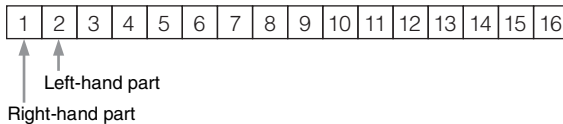

When you want to record a new track of an already recorded MIDI Song:

After selecting the target MIDI Song (steps 1 – 4 on pages 37 – 38), press and hold the [REC] button for a second to call up the display which lists the Recording Target Songs, select the 4th item (the selected MIDI Song), press the [▷] button, then go to step 2 described on this page.

1 Execute the same operations as in step 1 and step 2 on page 47 to enter the Recording mode with a new blank Song selected.

2 Use the [◀]/[▶] buttons to select a Recording Track.

When you want to record the right-hand part, highlight “R” (Track 1).

When you want to record the left-hand part, highlight “L” (Track 2).

Alternately, when you want to record your performance to Tracks 3 – 16, call up the desired one by pressing the [◀]/[▶] buttons repeatedly.



Recording Track

Track Data Status

 : Contains data.

 : Contains no data.

3 Play the keyboard to start recording.

When you want to record an empty section at the start of the Song, press the [PLAY/PAUSE] button to start recording.

4 After you finish your performance, press the [REC] button to stop recording.

This operation exits from the Recording mode and calls up the display for saving the recorded performance data.

NOTE

If you want to record your performance to the USB flash drive or you want to add the recording to the MIDI Song in the USB flash drive, refer to “MIDI Recording to the USB flash drive” (page 51).

NOTE

If you record your performance with both hands to R then to L, both are played back at the same time as a single Song.

Recording Track

Assignment for Duo

When Duo is on, only the performance on the Right section will be recorded to the specified track. The performance on the Left section will be recorded to a track number that is higher in number (by 3) than the specified track. If this exceeds 16, calculate the destination track starting back at 1.

NOTICE

Note that recording your performance to a Track containing data will overwrite the previously recorded data.

5 If you want to save the recorded performance, press the [▷] button to execute the Save operation while “Save” is highlighted.

After the Save operation is completed, the display shows “Save Completed” then returns to the Song display. The recorded Song will be named “USERSONGxxx” (xxx: number) and saved in the “User” category.



- If you are not satisfied with your performance and want to record again, highlight the cursor to “Retry” then press the [▷] button. Try recording again from step 3.
- If you do not want to save the recorded data, highlight “Cancel” then press the [▷] button.

6 To hear the recorded performance, press the [PLAY/PAUSE] button.

7 To record another Track, enter the Song Recording mode again.

7-1 Press and hold the [REC] button for a second.

The Recording Target Songs will be listed on the display.

7-2 Use the [▽] button to select existing MIDI Song (at the bottom of the list), then press the [▷] button.



You can check whether or not each Track contains recorded data by the indication that appears at the upper right of each Track. For details on the indication, refer to “Track Data Status” on page 49.

8 Record your performance to another track by repeating steps 2–6 of this section.

In step 2, select a track which has no recorded data. In step 3, play the keyboard while listening to the already recorded data.

NOTICE

The recorded MIDI Song will be lost if you change to another Song or you turn the power off without executing the save operation.

Renaming the recorded Song

The recorded Songs are named automatically, but you can rename Songs as desired (page 61).

NOTE

For instructions on rewinding, fast-forwarding and returning to the top of the Song during Song playback, refer to page 39.

NOTICE

Note that recording your performance to a Track containing data will overwrite the previously recorded data.

NOTE

Refer to page 59 for how to delete a Song. Refer to “Track Delete” on page 82 for how to delete a track.

MIDI Recording to the USB Flash Drive

MIDI

These instructions describe how to overwrite an already recorded MIDI Song in the USB flash drive or how to create a New MIDI Song on the USB flash drive.

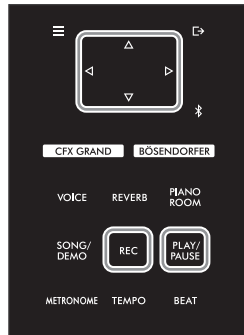

NOTE

- To connect a USB flash drive, be sure to read the section “Connecting USB Devices ([USB TO DEVICE] Terminal)” on page 64.
- Before starting the Recording operation, check the remaining memory capacity of the USB flash drive. “System” menu: “Utility” → “USB Properties” (page 88).

- 1 Connect the USB flash drive to the [USB TO DEVICE] terminal.
- 2 Select a MIDI Song as Recording target, then enter the Recording mode.
 - 2-1 If you want to record an additional Track to the already recorded MIDI Song, select the desired MIDI Song in the USB flash drive.
If you want to record from scratch, skip this step.
 - 2-2 Press and hold the [REC] button for a second to call up the display which lists the Recording Target Songs.



- 2-3 From the Recording Target Songs, select “New Song (USB)” or the MIDI Song selected in step 2-1 (4th item below) using the [Δ]/[▽] buttons, then press the [▷] button to enter the Recording mode.

Recording Target Song	Description
New Song	Select this when you want to record your performance to a blank MIDI Song and save to “User” category in this instrument’s internal memory.
New Song (USB)*	Select this when you want to record your performance to a blank MIDI Song and save to the USB flash drive.
New Audio (USB)*	Select this when you want to record your performance to blank audio data and save to the USB flash drive.
xxxxxx (MIDI Song selected in step 2-1 above)**	Select this when you want to record additionally to/overwrite the currently selected MIDI Song.

* Can be selected only when the USB flash drive is connected to the [USB TO DEVICE] terminal.

** Will not be shown when an already recorded MIDI Song is not selected in step 2-1 above, or when a Preset Song (Voice Demo, 50 Classical or Lesson) is selected in step 2-1.

3 Execute the Recording operation, then save the recorded performance.

When you want to record additionally to the currently selected MIDI Song, or record to a specified track on a blank MIDI Song:

Execute steps 2–8 in “MIDI Recording — Independent Tracks” on page 49.

When you want to quick record to a blank MIDI Song:

Execute steps 3–6 in “Quick MIDI Recording” on page 47.

NOTICE

Note that recording your performance to a Track containing data will overwrite the previously recorded data.

NOTE

The time signature and tempo cannot be changed when replacing the part of an existing MIDI Song.

Audio Recording to the USB Flash Drive

Audio

These instructions describe how to record your performance as audio data. Note that an audio file to which your performance is to be recorded can be saved only to a USB flash drive. This is why you should prepare your USB flash drive device before starting the Recording operation.

1 Connect the USB flash drive to the [USB TO DEVICE] terminal.

2 Press and hold the [REC] button for a second to call up the display which lists the Recording Target Songs.

3 Use the [△]/[▽] buttons to select “New Audio (USB)” then press the [▷] button.

4 Execute steps 3 – 6 in “Quick MIDI Recording” (page 47).

Unlike with MIDI Recording, the elapsed time is shown on the display while Audio Recording is being executed.



NOTE

- To connect a USB flash drive, be sure to read the section “Connecting USB Devices ([USB TO DEVICE] Terminal)” on page 64.
- Before starting the Recording operation, check the remaining memory capacity of the USB flash drive. “System” menu: “Utility” → “USB Properties” (page 88).
- With Audio recording, distorted sound may be produced if the Voice Volume is set to the value higher than the default setting. Make sure to set the Voice Volume to the default value or less before recording from the “Voice” menu: “Voice Edit” → “Volume” (page 78).
- With Audio recording, other audio input sounds (via Bluetooth, [AUX IN] etc.) from the external device (page 46) are also recorded.

Other Recording Techniques

Re-recording a MIDI Song in parts

MIDI

You can re-record a specific range of the MIDI Song.

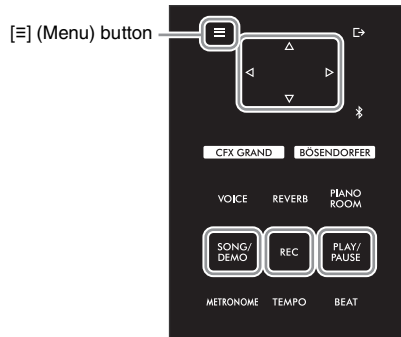

1 Set the parameters which determine how recording starts and stops.

1-1 Press the [≡] (Menu) button repeatedly to call up the “Recording” menu display.

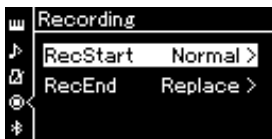

1-2 Use the [Δ]/[▽] buttons to select “RecStart,” then select the value which determines how recording starts by using the [▷] button.

Normal	The already recorded data will be replaced with the new one as soon as recording starts.
KeyOn	The already recorded data will be maintained until you press a key, and actual recording starts as soon as you press a key.

1-3 Use the [Δ]/[▽] buttons to select “RecEnd,” then select the value which determines how recording stops by using the [▷] button.

Replace	The data after the point you stop recording will also be erased.
PunchOut	The data after the point you stop recording will remain.

2 Press the [SONG/DEMO] button to call up the Song category list.

3 Select the desired MIDI Song.

For instructions, refer to page 37.

4 Specify the start point you wish to re-record.

Use the [**<**]/[**>**] buttons to move the playback position (measure number) to the desired point. Alternately, press the [PLAY/PAUSE] button to start playback, then press the [PLAY/PAUSE] button again slightly prior to the desired point.

If necessary, select the settings (Voice and other parameters).
Select the desired settings, if you wish to change the previous ones.

5 Press and hold the [REC] button for a second to call up the display which lists the Recording Target Songs, then select the 4th item (Song selected in step 3), then press the [>**] button to enter the recording mode.**

NOTE

The time signature cannot be changed when replacing the part of an existing Song.

6 Use the [<**]/[**>**] buttons to select a Track for re-recording.**

7 Play the keyboard or press the [PLAY/PAUSE] button to start recording.

8 Press the [REC] button to stop recording.

9 Save the recorded performance by following step 5 on page 50.

10 To hear the recorded performance, press the [PLAY/PAUSE] button.

Changing the tempo or the Voice of a previously recorded MIDI Song

MIDI

For MIDI Songs, you can change the tempo and Voice after recording to change a feel or to set a more suitable tempo.

• To change the tempo:

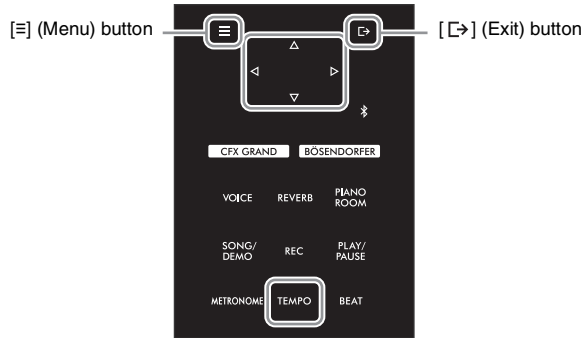

- 1 **Select the MIDI Song you wish to change.**
For instructions, refer to page 37.
- 2 **Press the [TEMPO] button to call up the “Tempo” display, then set the desired Tempo.**
For instructions, refer to page 39.
- 3 **Press the [≡] (Menu) button repeatedly to call up the “Song” menu display, then select the highlighted item in each display as illustrated below.**

“Song” menu display

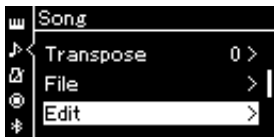

3-1. Use the [Δ]/[▽] buttons to select “Edit.”

3-2. Press the [▷] button to call up the next display.

“Edit” display



3-3. Use the [Δ]/[▽] buttons to select “Tempo Change.”

3-4. Press the [▷] button to call up the next display.

“Tempo Change” display



4 **Apply the selected Tempo value to the current MIDI Song data.**

Press the [▽] button to highlight “Execute,” then press the [▷] button to apply the new Tempo value to the current MIDI Song data.



When this operation is completed, “Completed” is shown on the display, and the Tempo Change display will be restored after a while.

5 **Press the [↵] (Exit) button to exit from the “Song” menu display.**

• **To change the Voice:**

1 Select the MIDI Song you wish to change.

For instructions, refer to page 37.

2 Select the desired Voice.

For instructions, refer to page 26.

3 Press the [≡] (Menu) button repeatedly to call up the “Song” menu display, then select the highlighted item in each display as illustrated below.

“Song” menu display

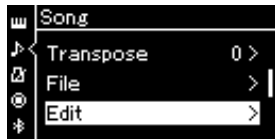

3-1. Use the [Δ]/[▽] buttons to select “Edit.”

3-2. Press the [▷] button to call up the next display.

“Edit” display

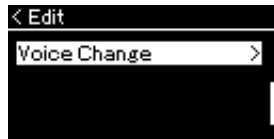

3-3. Use the [Δ]/[▽] buttons to select “Voice Change.”

3-4. Press the [▷] button to call up the next display.

“Voice Change” display

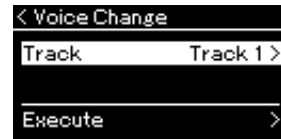

4 Press the [▷] button to call up the setting display, then select the desired Track using the [Δ]/[▽] buttons.

5 Apply the Voice selected in step 2 for the Track selected in step 4 to the current MIDI Song data.

Press the [◀] button to return to the Voice Change display. Press the [▽] button to highlight “Execute,” then press the [▷] button to apply the new Voice to the current MIDI Song data.



When this operation is completed, “Completed” is shown on the display, and the Voice Change display will be restored after a while.

6 Press the [↵] (Exit) button to exit from the “Song” menu display.

Handling Song Files

The “File” menu in the “Song” menu display (page 81) enables you to apply various operations to Song files— Songs you recorded on this instrument or commercially available Songs.

To connect a USB flash drive, be sure to read the section “Precautions when using the [USB TO DEVICE] terminal” on page 64.

Operation	File menu	Page
Deleting Song files	Delete	pages 58, 59
Copying Song files	Copy *	pages 58, 60
Moving Song files	Move *	pages 58, 60
Converting a MIDI Song to an Audio Song during playback	MIDI to Audio *	pages 58, 61
Renaming Song files	Rename	pages 58, 61

File

A file contains a group of data. On this instrument, a Song file includes Song data and a Song name.

File menu items indicated by “*” can be used only when a MIDI Song is selected.

Song Types and File Operation Limitations

Song types are indicated as the category name and icon in the Song display. The following chart shows the Song type and restrictions on File operations.

* The icon appears only when you select a Song in the “User” or “USB” category.



Data Location	Category	Song Type	Delete	Rename	Copy	Move	MIDI to Audio
	Instrument	Demo	Demo (Voice Demo)	x	x	x	x
50 Classical		50 classical Preset Songs	x	x	x	x	x
Lesson		Lesson Preset Songs	x	x	x	x	x
User		Your own recorded Songs (MIDI)	O	O	O	O	O
USB flash drive	USB	MIDI Songs	O	O	O	O	O
		Audio Songs	O	O	x	x	x

Range of the Copy/Move operation

As for a MIDI Song in the “User” category in the instrument, you can Copy/Move it only to the USER FILES folder on a USB flash drive. Selecting a MIDI Song from “User” for copying/moving automatically specifies the USER FILES folder as the destination.

As for a MIDI Song in a USB flash drive, you can Copy/Move it to the “User” category in the instrument.

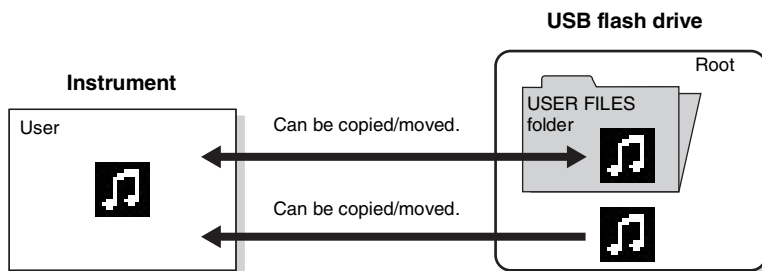

USER FILES folder

If the USB flash drive device plugged into the instrument contains no USER FILES folder, one will be created automatically when you format or record a Song to that device. The recorded Song will then be saved in that folder.

NOTE

- Please note that the copy features are intended for your personal use only.
- Folders cannot be copied.

Root:

The highest level of a hierarchical structure. This indicates an area which does not belong to a folder.

Basic Song File Operation

Song files can be handled via the instructions shown below.

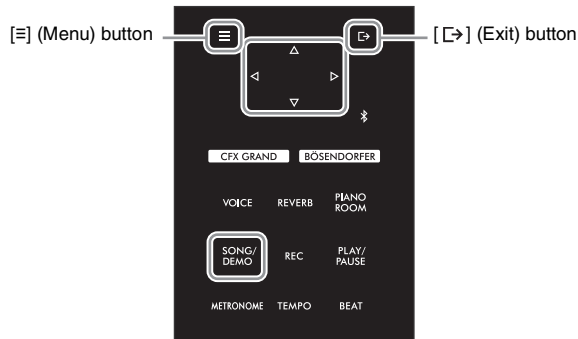

- 1 If necessary, connect a USB flash drive to the [USB TO DEVICE] terminal.
- 2 Select a Song for handling.
For information on selecting a Song, see page 37.
- 3 Enter the File mode.
 - 3-1 Press the [☰] (Menu) button repeatedly to call up the “Song” menu display. Use the [Δ]/[▽] buttons to select “File” then press the [➤] button.

“Song” menu display

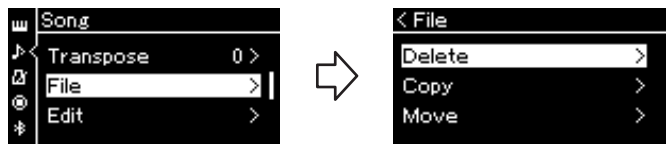

- 3-2 Select the desired operation from “Delete,” “Copy,” “Move,” “MIDI to Audio” or “Rename.”

For example: Renaming files



From here, if you wish to close the File mode, press the [⏏] (Exit) button once or twice.

4 Execute the selected operation.

For specific instructions, refer to the corresponding section.

- Delete page 59
- Copy page 60
- Move page 60
- MIDI to Audio page 61
- Rename page 61

During operation, messages (information, confirmation, etc.) may be shown on the display. For explanations and details, refer to “Message List” on page 98.

NOTICE

Do not disconnect the USB flash drive during file handling or when a USB flash drive is mounted. Doing so may delete all data in the USB flash drive and the instrument.

5 Press the [↵] (Exit) button to exit from the File mode.

Deleting Song Files — Delete

For details about Song types which can be deleted, refer to page 57.

See page 58 for information on basic operations. The following is a detailed procedure of step 4 on that page.

NOTE

You cannot delete multiple Songs at the same time.

4-1 While “Delete” is highlighted, press the [▶] button to call up the setting display.

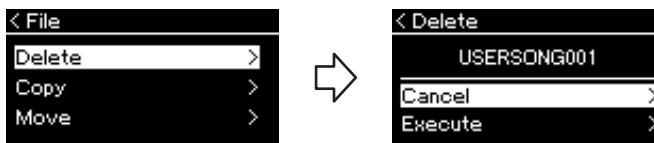

4-2 Highlight “Execute” by pressing [▽] button, and then press the [▶] button.

After the Song is deleted, the display returns to the Song List display.

NOTICE

Do not turn off the power or eject the USB flash drive while “Executing” is shown in the display.

Copying Song Files — Copy

For details about Song types and ranges that can be copied, refer to page 57.

See page 58 for information on basic operations. The following is a detailed procedure of step 4 on that page.

4-1 While “Copy” is highlighted, press the [▷] button to call up the setting display.

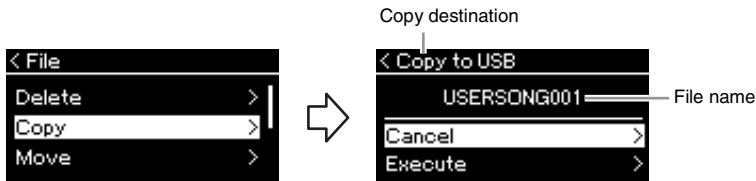

4-2 Highlight “Execute” by pressing [▽] button, then press the [▷] button.

The selected Song will be copied to the destination with the same name as the copy source file.

Copy destination:

“USB” will be shown when the copy destination is the USB flash drive or “User” when the instrument is the copy destination. A file copied to the USB flash drive is stored to the USER FILES folder on it.

NOTE

A message appears when a Song with the same name already exists in the copy destination. Select “Overwrite” when you want to overwrite the selected Song, or “Cancel” to cancel by using the [△]/[▽] buttons, and then press the [▷] button.

NOTICE

- **Overwrite operations** erase any existing data of the copy destination file and overwrite with data of the copy source file.
- **Do not turn off the power or eject the USB flash drive while “Executing” is shown in the display.**

Moving Song Files — Move

For details about Song types and ranges that can be moved, refer to page 57.

See page 58 for information on basic operations. The following is a detailed procedure of step 4 on that page.

4-1 While “Move” is highlighted, press the [▷] button to call up the setting display.

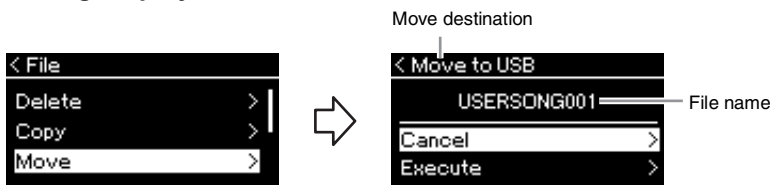

4-2 Highlight “Execute” by pressing the [▽] button, then press the [▷] button.

The selected Song will be moved to the destination and the display returns to the Song list display.

Move destination

“USB” will be shown when the move destination is the USB flash drive or “User” when the instrument is the move destination. A file moved to the USB flash drive is stored to the USER FILES folder on it.

NOTE

A message appears when a Song with same name already exists in the move destination. Select “Overwrite” when you want to overwrite the selected Song, or “Cancel” to cancel by using the [△]/[▽] buttons, then press the [▷] button.

NOTICE

- **Overwrite operations** erase any existing data of the move destination file and overwrite with data of the move source file.
- **Do not turn off the power or eject the USB flash drive while “Executing” is shown in the display.**

Converting a MIDI Song to an Audio Song During Playback — MIDI to Audio

A MIDI Song in the “User” memory of the instrument or on a USB flash drive can be converted to an Audio Song then saved to the USER FILES folder on a USB flash drive. For information about which Song types can be converted, refer to page 57.

See page 58 for information on basic operations. The following is a detailed procedure of step 4 on that page.

4-1 While “MIDI to Audio” is highlighted, press the [▷] button to call up the setting display.

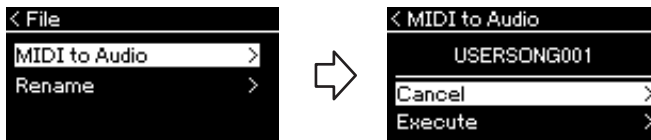

4-2 Highlight “Execute” by pressing the [▽] button, then press the [▷] button.

This operation starts playback and conversion from MIDI to Audio.

This is basically the same as that of Audio Song Recording, which allows you to record your keyboard performance and other audio input sounds (via Bluetooth, [AUX IN] etc.) from the external device (page 46). After you convert the Song, a message “Convert completed” will be shown and the display returns to Song List display.

NOTE

After conversion, the MIDI Song remains in the original data location.

NOTICE

Do not turn off the power or disconnect the USB flash drive during the conversion. Otherwise the data will be lost.

NOTE

- A message appears when a Song with same name already exists in the copy destination. Select “Overwrite” when you want to overwrite the selected Song by using the [△]/[▽] buttons, then press the [▷] button.
- To cancel this operation, press the [↵] (Exit) button during the conversion. When the operation is canceled, the converted Audio Song will not be saved.

Renaming Song Files — Rename

For details about Song types which can be renamed, refer to page 57.

See page 58 for information on basic operations. The following is a detailed procedure of step 4 on that page.

4-1 While “Rename” is highlighted, press the [▷] to call up the setting display.

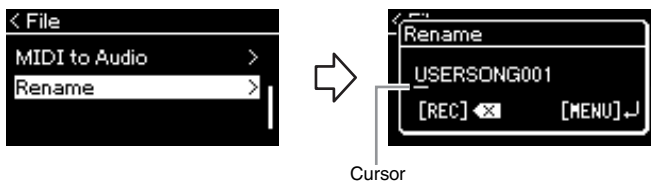

4-2 Assign a name to the Song.

Use the [◀]/[▶] buttons to move the cursor highlight (underline).

Use the [△]/[▽] buttons to change the character at the current cursor position.

Pressing the [REC] button will delete the character at the current cursor position.

A Song name can contain up to 46 characters. Characters which extend beyond the display capacity and are not visible can be viewed by moving the highlight by using the [◀]/[▶] buttons.

4-3 Press the [≡] (Menu) button to actually rename the file.

After the Song is renamed, the display returns to the Song List display where the renamed Song can be selected.

NOTE

For information about the character types available for the Song name, refer to “Language” on page 89.

NOTICE

Do not turn off the power or eject the USB flash drive while “Executing” is shown in the display.

Connecting to Other Devices

Connectors

You can connect other devices to this instrument's connectors. For information about location of these connectors, refer to "Panel Controls and Terminals" on page 12. You can also connect this instrument to a smart device such as a smartphone via Bluetooth (page 67).

NOTE

Before using the Bluetooth function, be sure to read "About Bluetooth" on page 67.

Terminal panel (at the bottom left of the keyboard)

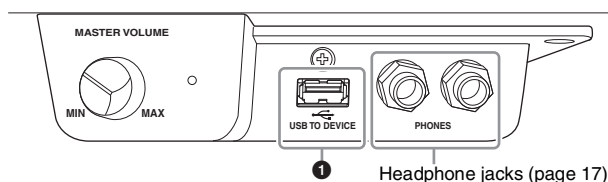

Terminal panel (at the bottom right of the keyboard)

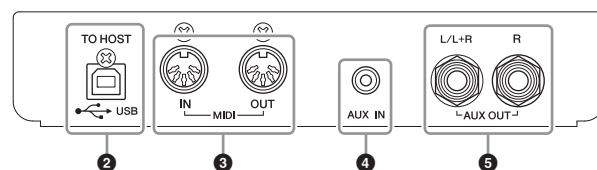

CAUTION

Before connecting the instrument to other electronic components, turn off the power of all the components. Also, before turning any components on or off, make sure to set all volume levels to minimum (0). Otherwise, damage to the components, electrical shock, or even permanent hearing loss may occur.

1 [USB TO DEVICE] terminal

You can connect a USB flash drive to this terminal, or use a USB wireless LAN adaptor UD-WL01 (sold separately) to connect with a smart device such as a smartphone. For details, refer to "Connecting to a Computer" (page 65) or "Using the Smart Device App "Smart Pianist"" (page 70). Before using the [USB TO DEVICE] terminal, be sure to read "Precautions when using the [USB TO DEVICE] terminal" on page 64.

2 USB [TO HOST] terminal

This terminal allows connection to a computer or a smart device, such as smartphone or tablet. For details, refer to "Connecting to a Computer" (page 65) or "Connecting to a Smart Device" (page 67).

3 MIDI [IN] [OUT] terminals

These terminals are used to connect external MIDI devices, such as a synthesizer or a sequencer. For details, refer to "Connecting External MIDI Devices (MIDI Terminals)" on page 65.

4 [AUX IN] jack

This jack is used to connect an audio player, such as a smartphone or portable audio player. For details, refer to "Connecting to an Audio Player ([AUX IN] jack)" on page 63.

5 AUX OUT [L/L+R] [R] jacks

These jacks are used to connect to external powered speaker systems (page 63).

NOTE

There are two different types of USB terminals on the instrument: [USB TO DEVICE] and USB [TO HOST]. Take care not to confuse the two terminals and the corresponding cable connectors. Be careful to connect the proper plug in the proper direction.

Connecting to an Audio Player ([AUX IN] jack)

You can connect the headphone jack of an audio player, such as a smartphone or portable audio player, to the instrument's [AUX IN] jack. Audio playback on the connected device is output from the built-in speakers of this instrument.

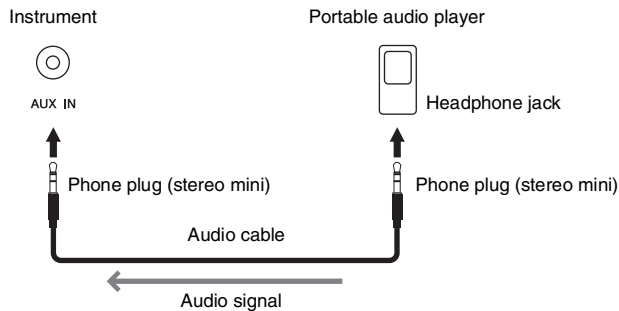

NOTE

- The instrument's [MASTER VOLUME] setting affects the input signal from the [AUX IN] jack.
- Use audio cables and adaptor plugs having no (zero) resistance.

NOTICE

To avoid damage to the devices, first turn on the power to the external device, and then to the instrument. When turning off the power, first turn off the power to the instrument, and then to the external device.

Using an External Speaker System for Playback (AUX OUT [L/L+R]/[R] jacks)

These jacks let you connect the instrument to external powered speaker systems, for playing in larger venues at higher volumes.

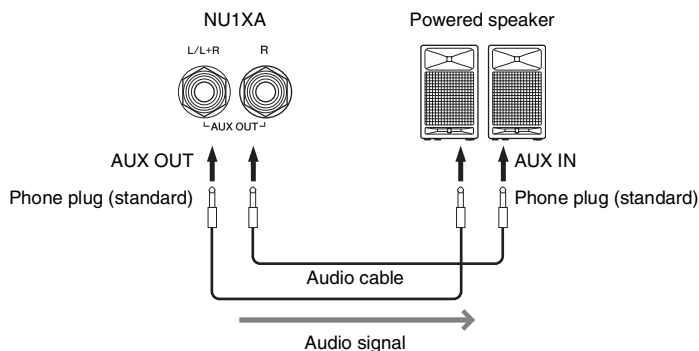

NOTE

- Use only the [L/L+R] jack for connection with a monaural device.
- Use audio cables and adaptor plugs having no (zero) resistance.
- When you are monitoring the sound output via the AUX OUT jacks from headphones connected to the instrument, we recommend that you set the Binaural Sampling and Stereophonic Optimizer functions to off. For details, refer to page 18.

NOTICE

- To avoid possible damage, first turn on the power to the instrument, then to the external device. When turning off the power, first turn off the power to the external device, then to the instrument. Since this instrument's power may automatically be turned off due to the Auto Power Off function (page 16), turn off the power to the external device, or disable Auto Power Off when you do not intend to operate the instrument.
- Do not route the output from the AUX OUT jacks to the [AUX IN] jack. If you make this connection, the signal input at the [AUX IN] jack is output from the AUX OUT jacks. These connections could result in a feedback loop that will make normal performance impossible, and may even damage the equipment.

The output volume from the AUX OUT jacks can be adjusted by the [MASTER VOLUME] control on the instrument. If you want to mute the speaker of the instrument while the external speakers are connected to the AUX OUT jacks, set the "Speaker" parameter to off via the "System" menu: "Utility" → "Speaker" (page 88).

Connecting USB Devices ([USB TO DEVICE] Terminal)

You can connect a USB flash drive or a USB wireless LAN adaptor UD-WL01 (sold separately) to the [USB TO DEVICE] terminal. You can save data you've recorded on the instrument to the USB flash drive (pages 46, 57), or you can connect the instrument to a smart device such as a smartphone via wireless LAN (page 71).

Precautions when using the [USB TO DEVICE] terminal

This instrument features a built-in [USB TO DEVICE] terminal. When connecting a USB device to the terminal, be sure to handle the USB device with care. Follow the important precautions below.

NOTE

For more information about the handling of USB devices, refer to the owner's manual of the USB device.

■ Compatible USB devices

- USB flash drive
- USB wireless LAN adaptor UD-WL01 (sold separately; may not be available in some areas)

Other USB devices such as a computer keyboard or mouse cannot be used.

The instrument does not necessarily support all commercially available USB devices. Yamaha cannot guarantee operation of USB devices that you purchase.

Before purchasing a USB device for use with this instrument, please visit the following web page:
<https://download.yamaha.com/>

Although USB devices 2.0 to 3.0 can be used on this instrument, the amount of time for saving to or loading from the USB device may differ depending on the type of data or the status of the instrument.

USB 1.1 devices cannot be used on this instrument.

NOTICE

The rating of the [USB TO DEVICE] terminal is a maximum of 5 V/500 mA. Do not connect USB devices having a rating above this, since this can cause damage to the instrument itself.

■ Connecting a USB device

When connecting a USB device to the [USB TO DEVICE] terminal, make sure that the connector on the device is appropriate and that it is connected in the proper direction.

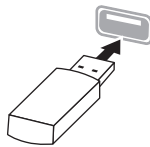

NOTICE

- Avoid connecting or disconnecting the USB device during playback/recording and file management operations (such as Save, Copy, Delete and Format), or when accessing the USB device. Failure to observe this may result in "freezing" of the operation of the instrument or corruption of the USB device and the data.
- When connecting then disconnecting the USB device (and vice versa), make sure to wait a few seconds between the two operations.
- Do not use extension or adaptor cables to connect USB devices.

Using USB Flash Drives

By connecting the instrument to a USB flash drive, you can save data you've created to the connected device, as well as read data from the connected USB flash drive.

■ Number of USB flash drives that can be used

Only one USB flash drive can be connected to the [USB TO DEVICE] terminal.

■ Formatting a USB flash drive

You should format the USB flash drive only with this instrument (page 88). A USB flash drive formatted on another device may not operate properly.

NOTICE

The format operation overwrites any previously existing data. Make sure that the USB flash drive you are formatting does not contain important data.

■ To protect your data (write-protect)

To prevent important data from being inadvertently erased, apply the write-protect provided with each USB flash drive. If you are saving data to the USB flash drive, make sure to disable write-protect.

■ Turning off the instrument

When turning off the instrument, make sure that the instrument is NOT accessing the USB flash drive by playback/recording or file management (such as during Save, Copy, Delete and Format operations). Failure to do so may corrupt the USB flash drive and the data.

Connecting External MIDI Devices (MIDI Terminals)

The sophisticated MIDI functions give you powerful tools to expand your music performance and creation possibilities. Use the MIDI terminals and standard MIDI cables to connect external MIDI devices (keyboard, sequencer, etc.)

- **MIDI [IN]:** Receives MIDI messages from another MIDI device.
- **MIDI [OUT]:** Transmits MIDI messages generated on this instrument to another MIDI device.

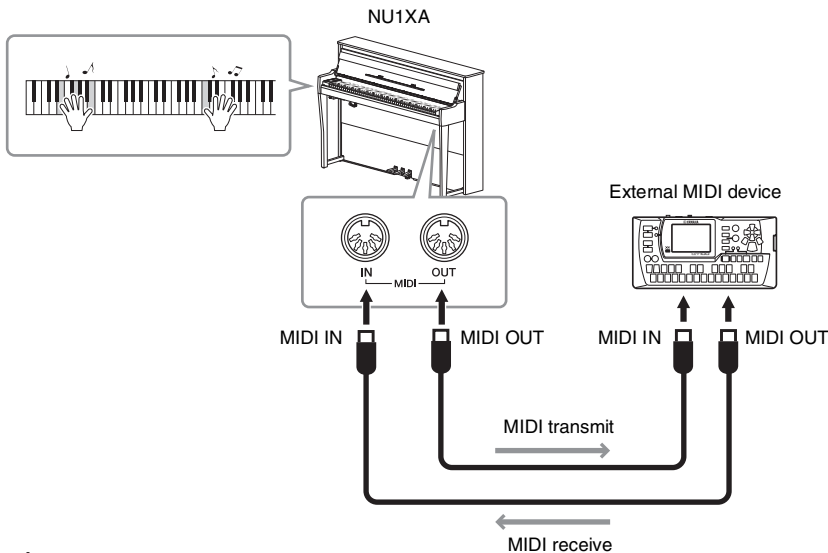

NOTE

- For details about MIDI, refer to “MIDI Basics” downloadable from the Yamaha website (page 9).
- Since MIDI data that can be transmitted or received varies depending on the type of MIDI device, check the MIDI Data Format to find out what MIDI data and commands your devices can transmit or receive. The MIDI Data Format is contained in the “MIDI Reference” downloadable from the Yamaha website (page 9).
- When transmitting MIDI data from this instrument to an external MIDI device, unexpected sounds may occur because of data related to the Grand Expression Modeling.



CAUTION

Before connecting the instrument to other MIDI devices, turn off the power of all the components.

Connecting to a Computer

By connecting a computer to the USB [TO HOST] terminal via a USB cable, you can transfer MIDI data or Audio data between the instrument and the computer. For details on using a computer with this instrument, refer to the “Computer-related Operations” on the website (page 9).

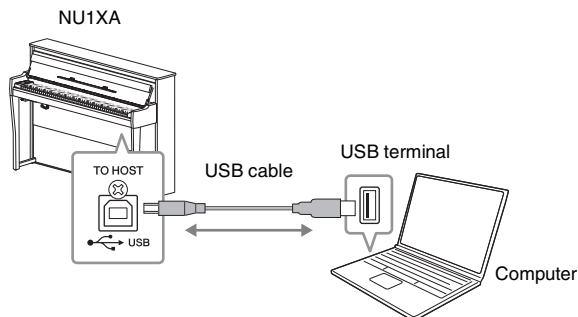

NOTE

- When using a USB cable to connect the instrument to your computer, make the connection directly without passing through a USB hub.
- For information on setting up your sequence software, refer to the owner's manual of the relevant software.
- The instrument will begin transmission a short time after the computer or smart device is connected.
- Unexpected sounds may occur if you edit MIDI data related to the Grand Expression Modeling on a computer.

NOTICE

- Use an AB type USB cable of less than 3 meters. USB 3.0 cables cannot be used.
- If you are using a DAW (digital audio workstation) application with this instrument, set the Audio Loopback function to off (see below). Otherwise, a loud sound may occur, depending on the settings of the computer or the application software.

Transmitting/Receiving Audio Data (USB Audio Interface function)

By connecting a computer or a smart device to the USB [TO HOST] terminal via a USB cable, digital audio data can be transmitted/received. This USB Audio Interface function provides the following advantages:

- **Playing back audio data with high sound quality**
This gives you direct, clear sound in which the sound quality has less noise and deterioration than that from the [AUX IN] jack.
- **Recording performance on the instrument as audio data by using a recording software or a music production software**
The recorded audio data can be played back on the computer or smart device.

For instructions on connecting to a computer, refer to “Computer-related Operations” on the website (page 9). To connect a smart device by using the smart device app “Smart Pianist,” refer to page 70.

Audio Loopback On/Off

This allows you to set whether audio sound input from the connected computer or smart device is output to a computer or a smart device or not along with the performance played on the instrument. To output the audio input sound, set the Audio Loopback to “On.”

For example, if you want to record the audio input sound as well as the sound played on the instrument by using the computer or the smart device, set this to “On.” If you intend to record only the sound played on the instrument by using the computer or the smart device, set this to “Off.” For details on the settings, refer to “Audio Loopback” on page 88.

NOTE

- When transmitting or receiving audio signals by using a computer running Windows, the Yamaha Steinberg USB Driver should be installed to the computer. For details, refer to the “Computer-related Operations” on the website.
- The volume of the audio sound input can be adjusted from a computer or smart device.

NOTE

- The Audio Loopback function also affects the audio input sound when using the Bluetooth Audio function (page 68) or the wireless LAN connection (page 71).
- The playback sound of an Audio Song (page 36) is also output to a computer or smart device when this is set to “On,” while the sound is not output when this is set to “Off.”
- With Audio Recording (page 52), the audio input sound from the connected computer or smart device is recorded when this is set to “On,” while the sound is not recorded when this is set to “Off.”

Connecting to a Smart Device

Connecting a smart device such as a smartphone or tablet allows you to enjoy the features shown below. You can listen to audio playback from a smart device on your instrument's speakers, or use a compatible smart device app to make playing this instrument easier and more fun. The method of connection varies depending on your intended use.

- **Transmitting/receiving audio data (USB Audio Interface function)**

Connect the device to this instrument's USB [TO HOST] terminal via a USB cable. For details, refer to page 66.

- **Listening to audio played back on a smart device through the speakers of this instrument (Bluetooth* Audio function)**

Connect the device to this instrument via Bluetooth. For details, refer to page 68.

- **Using the Smart Device App “Smart Pianist”**

Connect the device to this instrument via Bluetooth* or other methods. For details, refer to page 70.

NOTICE

Do not place your smart device in an unstable position. Doing so may cause the device to fall and result in damage.

About Bluetooth

Bluetooth capability

NU1XA is equipped with Bluetooth functionality; however, even these models may not support Bluetooth, depending on the country in which you purchased the product. If the Bluetooth logo is shown or printed on the control panel, this means that the product is equipped with Bluetooth functionality.

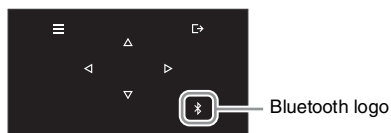

Bluetooth is a technology for wireless communication between devices within an area of about 10 meters (33 ft.) employing the 2.4 GHz frequency band.

- **Handling Bluetooth communications**

- The 2.4 GHz band used by Bluetooth compatible devices is a radio band shared by many types of equipment. While Bluetooth compatible devices use a technology minimizing the influence of other components using the same radio band, such influence may reduce the speed or distance of communications and in some cases interrupt communications.
- The speed of signal transfer and the distance at which communication is possible differs according to the distance between the communicating devices, the presence of obstacles, radio wave conditions and the type of equipment.
- Yamaha does not guarantee all wireless connections between this unit and devices compatible with Bluetooth function.

Listening to Audio Data from a Smart Device through this Instrument (Bluetooth Audio Function)

Before using the Bluetooth function, be sure to read "About Bluetooth" on page 67.

You can input the sound of the audio data saved in a Bluetooth-equipped device, such as a smart phone or digital audio player, to this instrument and listen to it through the built-in speaker of the instrument.

To use this function, make sure that Bluetooth is set to "On" (page 69) on the instrument (default setting: On).

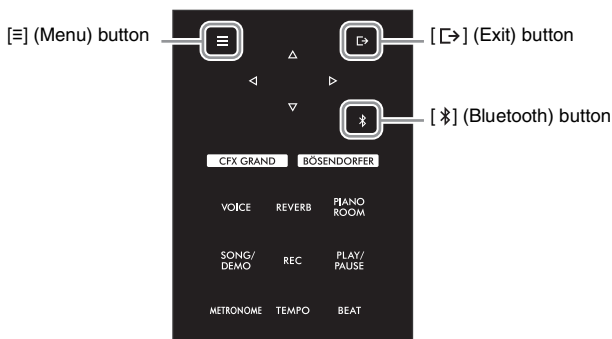

1 Hold down the [⌘] (Bluetooth) button for 3 seconds.

The pop-up window will appear which indicates that the instrument is standing by for pairing.



To cancel the pairing, press the [↪] (Exit) button

2 On the smart device, set the Bluetooth function to on and select "NU1XA AUDIO" from the connection list.

For details, refer to the smart device owner's manual.

After pairing is completed, the connection status will be shown in the display.

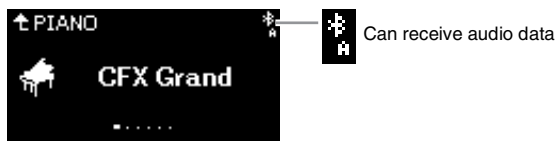

3 Play back audio data on the smart device to confirm that the built-in speakers of the instrument can output the audio sound.

When you turn on the instrument the next time, the last-connected smart device will be connected to this instrument automatically, if the Bluetooth function of the smart device and the instrument is set to on. If it is not connected automatically, select the model name of the instrument from the connection list on the smart device.

NOTE

- In this manual, a smart device is used as an example of a Bluetooth-equipped device which allows Bluetooth transmission of contained audio data to the instrument, via wireless communication. For proper operation, the device must be compatible with A2DP (Advanced Audio Distribution Profile). The Bluetooth Audio function is explained here by using a smart device as an example of such Bluetooth-equipped devices.
- Refer to page 70 for transmitting/receiving the MIDI data between the instrument and the smart device via Bluetooth.
- Bluetooth headphones or speakers cannot be paired.

Pairing

"Pairing" means to register Bluetooth-equipped smart devices on this instrument, and establish the mutual recognition for wireless communication between the two.

NOTE

- Only one smart device can be connected to this instrument at a time (although up to 8 smart devices can be paired to this instrument). When pairing with the 9th smart device has succeeded, pairing data for the device with the oldest connection date will be deleted.
- Make sure to complete the settings on the smart device within 5 minutes.
- If you are required to enter a passkey, enter the numerals "0000."

NOTE

You can adjust the volume of the sound input via Bluetooth by the [MASTER VOLUME] control. To adjust the volume balance between your keyboard performance and the input sound via Bluetooth, adjust the volume on the smart device.

Switching the Bluetooth Function On/Off

Before using the Bluetooth function, be sure to read “About Bluetooth” on page 67.

By default, the Bluetooth function will be on right after turning the instrument’s power on, however you can set the function to off.

- 1 Press the [≡] (Menu) button repeatedly to call up the “System” menu display, then select the highlighted item in each display as illustrated below.

“System” menu display

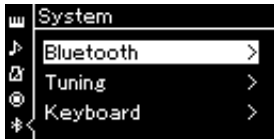

- 1-1. Confirm that “Bluetooth” is selected.
- 1-2. Press the [➤] button to call up the next display.

“Bluetooth” display

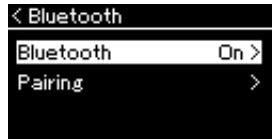

- 1-3. Confirm that “Bluetooth” is selected.

- 2 Press the [▶] button to switch on/off.

To exit from the “System” menu display, press the [↵] (Exit) button.

Using the Smart Device App “Smart Pianist”

By connecting a smart device such as a smartphone or tablet and using the Smart Pianist app, you can view the score of the preset Songs on the smart device, record your performance to the smart device, and perform other convenient operations. The intuitive visual interface helps you to confirm the current settings of the instrument.

For details on the app and compatible devices, access the website below and visit the “Smart Pianist” page.



<https://www.yamaha.com/2/apps/>

NOTICE

Activating the “Smart Pianist” app while the instrument is connected to the smart device overwrites the settings on the instrument by that of “Smart Pianist.” Save your important setup data as a backup file to a USB flash drive (page 92).

You can connect your smart device to this instrument via Bluetooth, USB cables or Wi-Fi. The “Connection Wizard” of Smart Pianist guides you in properly connecting the smart device to the instrument properly. After installing the Smart Pianist app on your smart device, tap [≡] (Menu) located at the upper left on the Smart Pianist screen to open the menu, and then tap “Instrument” followed by “Start Connection Wizard.”

For details on the connection methods as well as how to use the app, refer to the “Smart Pianist User Guide” on the following website.



<https://manual.yamaha.com/mi/app/smartpianist/>

This section explains the operations particular to this instrument. For the necessary settings on this instrument, follow the instructions below.

Connecting via Bluetooth

Before using the Bluetooth function, be sure to read “About Bluetooth” on page 67. Information on the availability of Bluetooth functionality is included or not can also be found on that page.

Two different types of Bluetooth connection are available: “Bluetooth MIDI” and “Bluetooth Audio.” You need to connect by Bluetooth MIDI to link and use Smart Pianist with the instrument. Bluetooth MIDI connection allows you to transmit and receive MIDI data between the instrument and the smart device. When connecting, select “NU1XA MIDI” on Smart Pianist as the device for connection.

If you connect by Bluetooth Audio as well, the audio data in the smart device can be played through Smart Pianist. Note that you cannot record your keyboard performance as audio format on Smart Pianist. For instructions on setting the Bluetooth Audio function, refer to page 68.

NOTE

When using the “Smart Pianist” app, you cannot use any buttons on the instrument other than the [↵] (Exit) button. Control the instrument by using “Smart Pianist.”

Pressing the [↵] (Exit) button on the instrument disconnects the instrument from the “Smart Pianist” app, and enables you to control the instrument by using its buttons.

When the Bluetooth connection is made successfully, the connection status is shown on the Voice display.

Voice display



Can transmit and receive MIDI data



Can transmit and receive MIDI data, and receive audio data

NOTE

If the Bluetooth function of this instrument is set to Off (default setting: On), the Bluetooth connection cannot be made. For information on the setting, refer to page 69.

Connecting via USB cables

Connect the smart device to the USB [TO HOST] terminal via USB cables. With this method, audio data as well as MIDI data can be transmitted or received between the instrument and the smart device. This allows you to play the audio data in the smart device through Smart Pianist, and also allows you to record your keyboard performance as audio format on Smart Pianist.

Connecting via Wi-Fi (by using the USB wireless LAN adaptor*)

*The USB wireless LAN adaptor UD-WL01 (sold separately) may not be available depending on your area.

Connect the smart device via Wi-Fi by connecting the USB wireless LAN adaptor UD-WL01 (sold separately) to the [USB TO DEVICE] terminal. With this method, audio data as well as MIDI data can be transmitted or received between the instrument and the smart device. This allows you to play the audio data in the smart device through Smart Pianist, and also allows you to record your keyboard performance as audio format on Smart Pianist.

Make either of the settings below, and then follow the “Connection Wizard” on Smart Pianist.

Connecting by the Infrastructure mode

The Infrastructure mode uses an access point for data communication between a USB wireless LAN adaptor and a network. You can use this mode when you connect to another network while a smart device is connected to the instrument.

- **Displaying the Wireless LAN networks and connecting to a network (page 72)**
- **Automatic Setup by WPS (page 73)**
- **Manual Setup (page 73)**

Connecting by the Accesspoint mode (page 74)

The Accesspoint mode allows you to directly connect the USB wireless LAN adaptor and a smart device, without the need for using an access point. You can use this mode when no access point is available for connection to the instrument, or when it is unnecessary to connect to another network while a smart device is connected to the instrument.

When connected by this mode, Internet access is disabled on your smart device, and some functions of Smart Pianist cannot be used.

NOTICE

Do not connect this product to public Wi-Fi and/or Internet directly. Only connect this product to the Internet through a router with strong password protections. Consult your router manufacturer for information on security best practices.

■ Displaying the Wireless LAN networks and connecting to a network

Make sure to connect the USB wireless LAN adaptor (sold separately) to the [USB TO DEVICE] terminal, otherwise the displays for setup below will not be shown.

NOTE

If the menus shown in the Wireless LAN display, are different from those shown here, the instrument is in the Accesspoint mode. Set the Wireless LAN Mode parameter to “Infrastructure Mode” by following the step 1 on page 74.

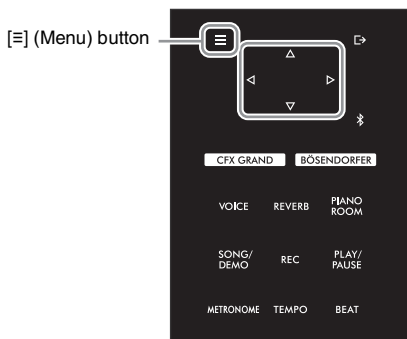

- 1 Press the [≡] (Menu) button repeatedly to call up the “System” menu display, and then select the highlighted item in each display as illustrated below.

“System” menu display

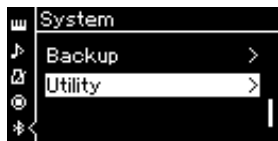

- 1-1. Use the [Δ]/[▽] buttons to select “Utility.”
- 1-2. Press the [▷] button to call up the next display.

“Utility” display

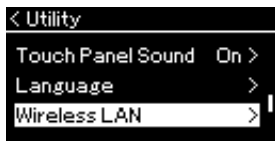

- 1-3. Use the [Δ]/[▽] buttons to select “Wireless LAN.”
- 1-4. Press the [▷] button to call up the next display.

“Wireless LAN” display

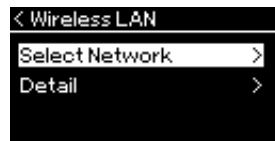

- 1-5. Use the [Δ]/[▽] buttons to select “Select Network.”

- 2 Press the [▷] button to call up the network list.

For a network with a lock icon (🔒), you need to enter the proper password.

NOTE

If no signal from the access point is received, the access point cannot be listed. Also, closed access points cannot be listed.

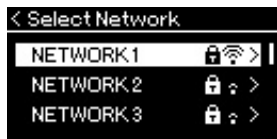

- 3 Connect the instrument to the Network.

- 3-1 Select the desired network, then press the [▷] button.

The name of the selected network will be fully shown in the display, letting you confirm this is the network you want to use.

- 3-2 Press the [▷] button.

For a network without a lock icon:

Connecting starts.

For a network with a lock icon:

You need to enter the proper password. For details on how to enter characters, refer to the “Renaming Song Files — Rename” on page 61. After entering the password, press the [≡] (Menu) button to finalize the setting. This operation starts connecting automatically.

When connection is done successfully, “Completed” is shown in the display, and returns to the “Select Network” display.

4 Connect the smart device to the access point.

Open the Wi-Fi settings on your smart device, and select the network containing “NU1XA” in the name field. If a password is requested, input it to connect.

■ Automatic Setup by WPS

Please make sure to connect the USB wireless LAN adaptor (sold separately) to the [USB TO DEVICE] terminal, otherwise the displays for setup will not be shown.

If your access point supports WPS, you can easily connect the instrument to access point by WPS, without making settings, such as password input, etc. Press the WPS button on the USB wireless LAN adaptor more than 3 seconds, and press the WPS button on your access point within two minutes. When connection is done successfully, “Completed” is shown in the display, and the Voice display will be shown.

Finally, connect the smart device to the access point (step 4 above).

■ Manual Setup

Make sure to connect the USB wireless LAN adaptor (sold separately) to the [USB TO DEVICE] terminal, otherwise the displays for setup will not be shown.

- 1 To call up the network list, perform steps 1 – 2 in the “Displaying the Wireless LAN Networks and connecting to a Network” (page 72).

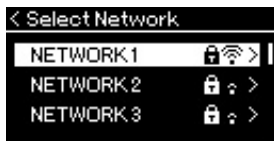

- 2 Select “Other” at the bottom of the network list, then press the [▷] button.
- 3 Set the SSID, Security and Password to the same as the settings on the access point.

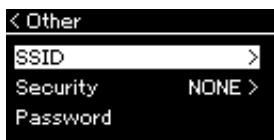

- 3-1 Select the “SSID” then press the [▷] button to call up the display for SSID input, then enter the SSID.
For details on how to enter the characters, refer to “Renaming Song Files — Rename” on page 61. After entering the SSID, press the [≡] (Menu) button to finalize the setting. Operation returns to the “Other” display.
- 3-2 Select “Security” then press the [▷] button to call up the Security list. Select the security then return to the “Other” display by pressing the [◀] button.
- 3-3 Select “Password,” then set the password in the same way as SSID.

NOTE

WPS setup is not available while the instrument is in the following modes or conditions:

- While a Song or a Demo Song is playing back or being paused temporarily, or while the instrument is in the Song Recording mode.
- When Wireless LAN mode is set to “Accesspoint Mode” in the “System” menu.

NOTE

The password cannot be set when you select “none” for the security setting.

4 Select “Connect >” at the bottom of the display shown in step 3, then press the [▷] button to start connecting.

When connection is done successfully, “Completed” is shown in the display, and returns to the “Select Network” display.

5 Connect the smart device to the access point.

This operation is the same as step 4 on page 73.

■ Connecting by the Accesspoint Mode

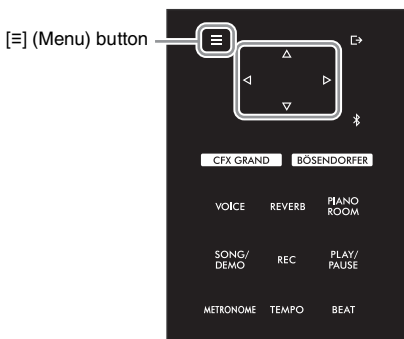

1 Switch the instrument to the “Accesspoint Mode.”

Press the [≡] (Menu) button repeatedly to call up the “System” menu display, then select the highlighted item in each display as illustrated below.

“System” menu display

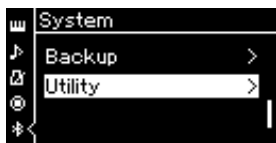

- 1-1. Use the [Δ]/[▽] buttons to select “Utility.”
- 1-2. Press the [▷] button to call up the next display.

“Utility” display

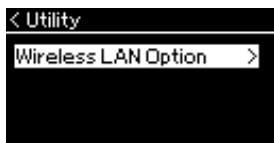

- 1-3. Use the [Δ]/[▽] buttons to select “Wireless LAN Option.”
- 1-4. Press the [▷] button to call up the next display.

“Wireless LAN Option” display

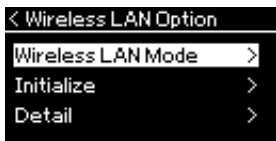

- 1-5. Use the [Δ]/[▽] buttons to select “Wireless LAN Mode.”
- 1-6. Press the [▷] button to call up the next display.

“Wireless LAN Mode” display

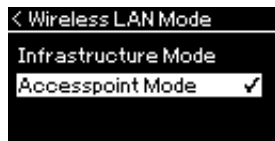

- 1-7. Use the [Δ]/[▽] buttons to select “Accesspoint Mode.”

When mode change is done successfully, “Completed” is shown in the display, operation returns to the “Wireless LAN Mode” display.

2 Set SSID, Security, Password and Channel.

2-1 From the “System” menu display, select the highlighted item in each display as illustrated below.

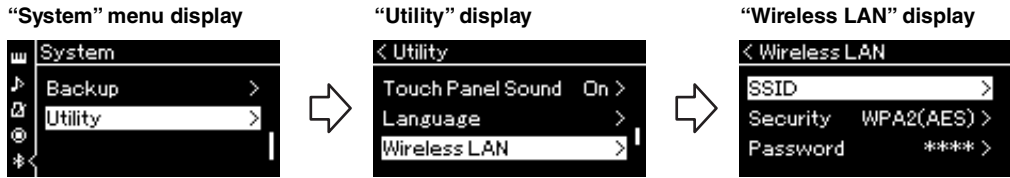

2-2 Set the SSID, Security, Password and Channel.

Select and enter each value/setting in the same way as in step 3 in “Manual Setup.” For the setting range for each item, refer to “Wireless LAN” (In the Accesspoint mode) on page 91.

3 Save the setting.

Select “Save >” at the bottom of the Wireless LAN display, then press the [▷] button to start saving. When saving is done successfully, “Completed” is shown in the display, and operation returns to the “Utility” display.

4 Connect the smart device to the instrument (as an access point).

This operation is the same as step 4 on page 73.

Detailed Settings (Menu Display)

Pressing the [≡] (Menu) button opens one of the five menu displays (Voice, Song, Metronome, Recording and System). You can make settings for various functions from these menu displays.

Common Operations in the Menu Displays

1 As necessary, select the desired Voice or Song for editing.

For example, if you want to set Song playback parameters, such as Repeat, select the Song. If you want to set Voice related parameters, such as Chorus, select the Voice to add the effect.

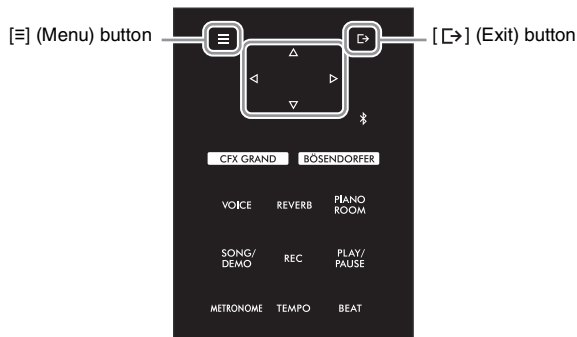

2 Press the [≡] (Menu) button several times to select the desired menu.

Pressing the [≡] (Menu) button repeatedly will call up the following menu displays in order, according to the vertical menu at the left of the display.

- Voice menu (page 77)
- Song menu (page 81)
- Metronome menu (page 84)
- Recording menu (page 84)
- System menu (page 85)

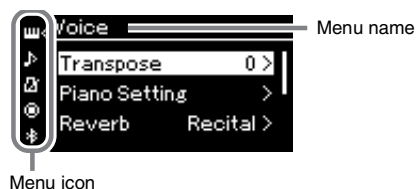

3 Use the [Δ]/[▽]/[◀]/[▶] buttons to select the desired parameter.

While referring as needed to the parameter list on each page listed in step 2, use the [Δ]/[▽] buttons to navigate through the display vertically and use the [◀]/[▶] buttons to navigate through display horizontally.

	[▶]	[▶]	[▶]
	[◀]	[◀]	[◀]
L/R*	R, L, Other		-
Repeat	A - B*		(Setting displ.)
	Phrase*		Phrase Mark

4 In the display called up in step 2, use the [Δ]/[▽]/[◀]/[▶] buttons to select a value or execute the operation.

Most displays allow you to select a value by simply using the [Δ]/[▽] buttons, although some, such as Edit in the "Song" menu and Backup in the "System" menu, let you execute an operation.

If a pop-up window is shown, set the value with the [◀]/[▶] buttons, then exit from the window using the [↵] (Exit) button.

Also, when the selected parameter provides only two options (on and off, for example), simply pressing the [▶] button will alternate the value between the two options.



5 To exit from the menu display, press the [↵] (Exit) button.



Voice Menu

This menu lets you edit or set various parameters related to keyboard performance, such as Voice parameters. By turning on Duo, you can make the settings for each Voice or each Voice combination. While playing the keyboard and hearing the sound, change a parameter value to find your desired sound. Note that you should turn on Duo before calling up the “Voice” menu.

NOTE

Parameters with * are shown only when Duo (page 32) is on.

To call up the desired parameter:

Turn on Duo as necessary, select Voices as necessary, press the [≡] (Menu) button several times to select “Voice” menu, then use the [△]/[▽]/[<]/[>] buttons to select the desired parameter.

[>] [<]	[>] [<]	[>] [<]	Description	Default setting	Setting range
Transpose	(Pop-up window)	–	Shifts the pitch of the entire keyboard up or down in semitone intervals to facilitate playing in difficult key signatures, and to let you easily match the pitch of the keyboard to the range of a singer or other instruments. For example, if you set this parameter to “5,” playing key C produces pitch F. In this way, you can play the F major song as if it were in C major. NOTE <ul style="list-style-type: none"> The setting here will not affect Song playback. If you want to transpose Song playback, use the “Transpose” parameter in the “Song” menu (page 81). Your keyboard performance data will be transmitted with the transposed note numbers while MIDI note numbers received from an external MIDI device or computer will not be affected by the Transpose setting. 	0	–12 (–1 octave) – 0 (normal pitch) – +12 (+1 octave)
Piano Setting	Lid Position	(Setting display)	Refer to the description of “Lid Position” on page 24.		
	VRM	–	Refer to the description of “VRM” on page 24. Demo cannot be played in “Voice” menu. NOTE VRM is effective only for Voices in the Piano group.		
	Damper Res. (Resonance)	(Setting display)			
	Damper Noise	–			
	String Res. (Resonance)	(Setting display)			
	Duplex Scale Res. (Resonance)	(Setting display)			
	Body Res. (Resonance)	(Setting display)			
Grand Exp. (Expression)	–	Refer to the description of “Grand Expression” on page 25. Demo cannot be played in “Voice” menu. NOTE Grand Expression Modeling is effective only for the Voices of “CFX Grand” and “Bösendorfer.”			
Reverb	(Setting display)	–	Determines the Reverb type which is applied to all the entire sound including the keyboard performance, Song playback and MIDI data input from an external MIDI device.	Differs depending on the Voice or Voice combination.	Refer to the Reverb Type List (page 29).
Chorus	(Setting display)	–	Determines the Chorus type which is applied to all the entire sound including the keyboard performance, Song playback and MIDI data input from an external MIDI device.	Differs depending on the Voice or Voice combination.	Refer to the Chorus Type List (page 80).

To call up the desired parameter:

Turn on Duo as necessary, select Voices as necessary, press the [=] (Menu) button several times to select “Voice” menu, then use the [Δ]/[▽]/[◀]/[▶] buttons to select the desired parameter.

[▶] [◀]	[▶] [◀]	[▶] [◀]	Description	Default setting	Setting range
Voice Edit	(Voice names)* * Shown when Duo is on (Upper: Right section Voice; Lower: Left section Voice)	Octave	Shifts the pitch of the keyboard up and down in octave steps.	Differs depending on the Voice or Voice combination.	-2 (two octaves lower) – 0 (no pitch shift) – +2 (two octaves higher)
		Volume	Adjusts the volume for the selected Voice.	Differs depending on the Voice or Voice combination.	0 – 127
		Reverb Depth	Adjusts the Reverb depth for the selected Voice. The “0” setting will produce no effect. NOTE When a VRM Voice is used for several parts simultaneously, unexpected sounds may result since the Reverb depth for a part which has priority will become the common setting for the parts. During Song playback, setting for a Song part is used (priority order: Ch. 1, Ch. 2...Ch. 16), while the setting for a keyboard part is used when Song playback is stopped (priority order: Right section, Left section in Duo).	Differs depending on the Voice or Voice combination.	0 – 40
		Chorus Depth	Adjusts the Chorus depth for the selected Voice. The “0” setting will produce no effect. NOTE When a VRM Voice is used for several parts simultaneously, unexpected sounds may result since the Chorus depth for a part which has priority will become the common setting for the parts. During Song playback, setting for a Song part is used (priority order: Ch. 1, Ch. 2...Ch. 16), while the setting for a keyboard part is used when Song playback is stopped (priority order: Right section, Left section in Duo).	Differs depending on the Voice or Voice combination.	0 – 127
		Effect	In addition Reverb and Chorus, another Effect can be applied to the selected Voice. This lets you select the Effect type.	Differs depending on the Voice or Voice combination.	Refer to the Effect Type List (page 80).
		Rotary Speed	Available only for the Voice of which the Effect Type is set to “Rotary.” This parameter determines the rotation speed of the Rotary Speaker effect.	Differs depending on the Voice or Voice combination.	Fast, Slow
		VibeRotor	Available only for the Voice of which the Effect Type is set to “VibeRotor.” This parameter turns on or off the VibeRotor effect.	Differs depending on the Voice or Voice combination.	On, Off
		VibeRotor Speed	Available only for the Voice of which the Effect Type is set to “VibeRotor.” This parameter determines the speed of the Vibraphone vibrato effect.	Differs depending on the Voice or Voice combination.	1 – 10
		Effect Depth	Adjusts the Effect depth for the selected Effect above. Note that some Effect types do not allow you to adjust the depth.	Differs depending on the Voice or Voice combination.	1 – 127
		Pan	Adjusts the stereo pan position for the selected Voice.	Differs depending on the Voice or Voice combination.	L64 (leftmost) – C (center) – R63 (rightmost)

To call up the desired parameter:

Turn on Duo as necessary, select Voices as necessary, press the [=] (Menu) button several times to select “Voice” menu, then use the [△]/[▽]/[<]/[>] buttons to select the desired parameter.

[>] [<]	[>] [<]	[>] [<]	Description	Default setting	Setting range
Voice Edit	(Voice names)* * Shown when Duo is on (Upper: Right section Voice; Lower: Left section Voice)	Harmonic Cont	Produces a distinctive “peaky” tone by raising the Resonance value of the Filter. NOTE Harmonic content may have little audible effect or not be applied to some Voices.	Differs depending on the Voice or Voice combination.	-64 – +63
		Brightness	Adjusts the brightness of the selected Voice.	Differs depending on the Voice or Voice combination.	-64 – +63
		Touch Sens.	Determines the degree to which the volume level changes in response to your touch on the keyboard (how hard you play). Since the volume level of some Voices such as Harpsichord and Organ do not change regardless of how you play the keyboard, the default setting for these Voices is 127.	Differs depending on the Voice or Voice combination.	0 (softest) – 64 (largest changes in the level) – 127 (which produces the loudest volume regardless of how you play the keyboard)
		RPedal	Turns the Right pedal function on or off for the selected Voice. This parameter is useful when you want to ensure, for example, that the pedal function affects the Right section but does not affect the Left section while playing in Duo.	Differs depending on the Voice or Voice combination.	On, Off
		CPedal	Turns the Center pedal function on or off for the selected Voice. This parameter is useful when you want to ensure, for example, that the pedal function affects the Right section but does not affect the Left section while playing in Duo.	Differs depending on the Voice or Voice combination.	On, Off
		LPedal	Turns the Left pedal function on or off for the selected Voice. This parameter is useful when you want to ensure, for example, that the pedal function affects the Right section but does not affect the Left section while playing in Duo.	Differs depending on the Voice or Voice combination.	On, Off
Pedal Assign	Right	(Setting display)	Assigns one of various functions (other than the original one) to the Right pedal.	SustainCont	Refer to the Pedal Function List (page 80).
	Center	(Setting display)	Assigns one of various functions (other than the original one) to the Center pedal.	Sostenuto	Refer to the Pedal Function List (page 80).
	Left	(Setting display)	Assigns one of various functions (other than the original one) to the Left pedal.	Rotary Speed (Jazz Organ), Vibe Rotor (Vibraphone), Soft (other Voices)	Refer to the Pedal Function List (page 80).
Balance*	Volume L – R	(Pop-up window)	Adjusts the volume balance between the Right and Left sections when using the Duo function (page 32). After adjusting via the [<]/[>] buttons, press the [↵] (Exit) button to exit from the pop-up window.	Differs depending on the Voice or Voice combination.	L+10 – 0 – R+10

■ Chorus Type List

Off	No effect
Chorus	Adds a rich, spacious sound.
Celeste	Adds swell and a spacious sound.
Flanger	Adds swell effects similar to the sound of an ascending or descending jet plane.

■ Effect Type List

Off	No effect
DelayLCR	Delay applied at left, center, and right positions.
DelayLR	Delay applied at left and right positions.
Echo	Echo-like delay
CrossDelay	Left and right delays cross each other in alternation.
Symphonic	Adds a rich and deep acoustic effect.
Rotary	Adds the vibrato effect of a rotary speaker.
Tremolo	The volume level changes in rapid cycles.
VibeRotor	The vibrato effect of a vibraphone.
AutoPan	The sound pans left to right and back and forth.
Phaser	The phase changes periodically, swelling the sound.
AutoWah	The center frequency of the wah filter changes periodically.
Distortion	Distorts the sound.

■ Pedal Function List

Function	Description	Available pedal (O: Can be assigned, x: Cannot)		
		Left pedal	Center pedal	Right pedal
Sustain (Switch)	On/off switch type damper	O	O	O
Sustain Continuously	Damper that sustains the sound proportionately to how deeply you press the pedal (page 19)	x	x	O
Sostenuto	Sostenuto (page 19)	O	O	O
Soft	Soft (page 19)	O	O	O
PitchBend Up*	A function that smoothly raises the pitch	x	x	O
PitchBend Down*	A function that smoothly lowers the pitch	x	x	O
Rotary Speed	Changes the rotational speed of the Jazz Organ rotary speaker (switches between fast and slow each time you press the pedal)	O	O	O
VibeRotor	Switches the vibraphone vibrato on/off (switches on/off each time you press the pedal)	O	O	O



Song Menu

This menu lets you set various parameters related to Song playback and edit the Song data. Select a desired Song before beginning the operation.

NOTE

- The parameters marked with * will be available only when a MIDI Song is selected. These parameters are not shown when an Audio Song is selected.
- The parameters marked with ** will be available only when an Audio Song is selected.
- When using the “Edit” menu, select a MIDI Song other than the preset Song.
- Execute is a function that edits or changes the current Song data. Note that pressing the [▷] button will actually change the Song data.
- The content of the “Song” menu differs depending on the type of Song currently selected (MIDI/Audio).

To call up the desired parameter:

Select a Song as necessary, press the [≡] (Menu) button several times to select “Song” menu, then use the [△]/[▽]/[◀]/[▶] buttons to select the desired parameter.

[▷] [◀]	[▷] [◀]	[▷] [◀]	Description	Default setting	Setting range
L/R*	R, L, Extra	–	Turns on (Play) or off (Mute) each of the Song tracks. For details, refer to page 40.	On	On, Off
Repeat	A - B*	(Setting display)	Lets you play back a specified range (from Point A to B) of the current Song repeatedly. For instructions, refer to page 41.	Off	On, Off
	Phrase*	Phrase Mark	This parameter is available only when a MIDI Song containing the Phrase Mark. By specifying a Phrase number here, you can play back the current Song from the mark point, or to play back the corresponding phrase repeatedly. If you start Song playback with a Phrase set to “On,” the countdown starts, followed by repeated playback of the specified phrase or phrases until you press the [PLAY/PAUSE] button.	000	000 – the last phrase number of the Song
		Repeat			Off
	Song	(Setting display)	By setting this parameter, you can play back only a specific Song, or specific Songs in order repeatedly or randomly. For details, refer to page 41.	Off	Off, Single, All, Random
Volume	Song – Keyboard*	(Pop-up window)	Adjusts the volume balance between the Song playback sound and keyboard performance.	0	Key+64 – 0 – Song+64
	Song L – R*	(Pop-up window)	Adjusts the volume balance between the right-hand part left-hand parts of Song playback.	0	L+64 – 0 – R+64
		(Pop-up window)**	Adjusts the Audio volume.	100	0 – 127
Transpose	(Setting display)	–	Shifts the pitch of Song playback up or down in semitone intervals. For example, if you set this parameter to “5,” a Song created in C major will be played back in F major. NOTE • The Transpose setting will not affect the audio input sound (via Bluetooth, [AUX IN], etc.) from the external device (page 46). • MIDI Song playback data will be transmitted with the transposed note numbers while MIDI note numbers received from an external MIDI device or computer will not be affected by the Transpose setting. • Applying transpose to an Audio Song may change its tonal characteristics.	0	–12 (–1 octave) – 0 (normal pitch) – +12 (+1 octave)
File	Delete	Cancel	Deletes a specific Song. For details about Song types which can be deleted, refer to page 57.	–	–
		Execute		–	–
	Copy*	Cancel	Copies a specific MIDI Song then saves it to a different location. For details about Song types which can be copied, refer to page 57.	–	–
		Execute		–	–

To call up the desired parameter:

Select a Song as necessary, press the [≡] (Menu) button several times to select “Song” menu, then use the [△]/[▽]/[<] / [>] buttons to select the desired parameter.











[>] [<]	[>] [<]	[>] [<]	Description	Default setting	Setting range
File	Move*	Cancel	Moves a MIDI Song to a different location. For details about Song types which can be moved, refer to page 57.	–	–
		Execute		–	–
	MIDI to Audio*	Cancel	Converts a MIDI Song to an Audio file. For details about Song types which can be converted, refer to page 57.	–	–
		Execute		–	–
	Rename	(Setting display)	Edits a Song name. For details about Song types which can be renamed, refer to page 57.	–	–
	Edit*	Quantize	Quantize	The Quantize function allows you to align all the notes in the current MIDI Song to the correct timing, such as 8th note or 16th note. 1. Set the Quantize value to the smallest notes in the MIDI Song. 2. Set the Strength value which determines how strongly the notes will be quantized. 3. Move the highlight to “Execute” then press the [>] button to actually change the MIDI Song data.	1/16
Strength			100%		0% – 100% Refer to “Strength setting range.” (page 83)
Execute			–		–
Track Delete		Track	Deletes a specific track data of the current MIDI Song. 1. Select the desired track to be deleted. 2. Move the highlight to “Execute,” then press the [>] button to actually delete the specified track data.	Track 1	Track 1 – Track 16
		Execute		–	–
Tempo Change		Cancel	Changes the tempo value of the current MIDI Song as data. Before calling up the “Song” menu display, set the desired Tempo value for changing. Move the highlight to “Execute,” then press the [>] button to actually change the Tempo value as MIDI Song data.	Differs depending on the Song	–
		Execute		–	–
Voice Change		Track	Changes the Voice of a specific track in the current MIDI Song to the current Voice as data. 1. Select a track of which the Voice will be changed. 2. Move the highlight to “Execute,” then press the [>] button to actually change the Voice as MIDI Song data.	Track 1	Track 1 – Track 16
		Execute		–	–
Others**		Quick Play	–	This parameter enables you to specify whether a Song that starts from the middle of a bar, or a Song with a silence prior to the first note, should be played from the first note or from the top of the bar (rest or blank). This parameter is useful for a MIDI Song that starts with a short one-or two-beat pick-up or lead-in.	On
	Track Listen	Track	This lets you play back only the selected Track to listen to its contents. To do this, select a Track, move the highlight to “Start,” then press and hold the [>] button to start playback from the first note. Playback continues while holding the [>] button.	Track 1	Track 1 – Track 16
		Start			
Play Track	–	This parameter enables you to specify the tracks for playing back on this instrument. When “1&2” is selected, only tracks 1 and 2 will be played back, while tracks 3 to 16 will be transmitted via MIDI. When “All” is selected, all tracks will be played back on this instrument.	All	All, 1&2	

NOTE

Tempo of Song playback can be set on the display called up by pressing the [TEMPO] button. For instructions, refer to page 39.

■ Quantize Supplementary

Quantize setting range

1/4.....		quarter note
1/6.....		quarter note triplet
1/8.....		eighth note
1/12.....		eighth note triplet
1/16.....		sixteenth note
1/24.....		sixteenth note triplet
1/32.....		thirty-second note
1/8+1/12.....		eighth note + eighth note triplet*
1/16+1/12.....		sixteenth note + eighth note triplet*
1/16+1/24.....		sixteenth note + sixteenth triplet*

The three Quantize settings marked with asterisks (*) are exceptionally convenient, since they allow you to quantize two different note values at the same time. For example, when the straight eighth notes and eighth notes triplet are contained in the same part, if you quantize by straight eighth notes, all notes in the part are quantized to straight eighth notes—completely eliminating any triplet feel. However, if you use the eighth note + eighth note triplet setting, both the straight and triplet notes will be quantized correctly.

Strength setting range

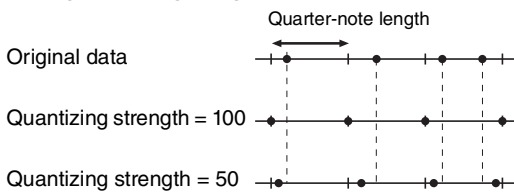

Metronome Menu

This menu lets you set the volume and tempo indication format of the Metronome (page 34). Regarding “Time Signature” and “Bell,” these are also described on page 35.

To call up the desired parameter:
 Press the [≡] (Menu) button several times to select “Metronome” menu, then use the [△]/[▽] buttons to select the desired parameter.

[▷] [◁]	[▷] [◁]	[▷] [◁]	Description	Default setting	Setting range
Time Sig. (Time Signature)	(Setting display)	–	Determines the time signature of the metronome. When you select or playback MIDI Songs, this will automatically be changed to the time signature of the selected songs.	4/4	2/2, 3/2, 1/4, 2/4, 3/4, 4/4, 5/4, 6/4, 7/4, 3/8, 6/8, 7/8, 9/8, 12/8
Volume	(Pop-up window)	–	Determines the volume of the Metronome or Rhythm. You can adjust the volume balance between the keyboard performance and Metronome/Rhythm playback.	82	0 – 127
BPM	–	–	Determines whether the note type of the tempo indication is affected by the Metronome Time Signature (page 35) or not (crotchet). When “Time Sig.” is selected, the denominator of the Time Signature is shown as the note type of the tempo indication. (The dotted quarter note is shown as the note type of the tempo indication only when the Time Signature is set to “6/8,” “9/8,” or “12/8.”)	Time Sig.	Time Sig., Crotchet
Bell	–	–	Determines whether or not the bell sound is played back at the first beat of the specified Time Signature.	Off	On, Off

Recording Menu

This menu lets you make detailed settings related to MIDI Recording (page 46).

NOTE

The settings here will not affect Audio Recording.

To call up the desired parameter:
 Press the [≡] (Menu) button several times to select “Recording” menu, then use the [△]/[▽] buttons to select the desired parameter.

[▷] [◁]	[▷] [◁]	[▷] [◁]	Description	Default setting	Setting range
RecStart	–	–	This parameter, which is used when you overwrite the already recorded MIDI Song, determines when the actual MIDI Recording starts after you execute the Recording Start operation. When set to “Normal,” actual recording will starts as soon as you execute the Recording Start operation. When set to “KeyOn,” actual recording starts as soon as you press any key after you execute the Recording Start operation.	Normal	Normal, KeyOn
RecEnd	–	–	This parameter, which is used when you overwrite the already recorded MIDI Song, determines whether the existing data after the point at which you stop recording will be erased or not.	Replace	Replace, PunchOut

System Menu

This menu lets you make the overall settings applied to the entire instrument.

NOTE

Parameters marked with * are available only if the instrument is equipped with Bluetooth functionality.

To call up the desired parameter:

Press the [≡] (Menu) button several times to select "System" menu, then use the [△]/[▽]/[<]/[>] buttons to select the desired parameter.

[>] [<]	[>] [<]	[>] [<]	Description	Default setting	Setting range
Bluetooth*	Bluetooth	–	Switches the Bluetooth function on/off (page 69).	On	On, Off
	Pairing	–	For registering (pairing) the Bluetooth equipped-device (page 68). This parameter is shown only when "Bluetooth" (above) is set to "On."	–	–
Tuning	Master Tune	(Pop-up window)	Fine tunes the pitch of the entire instrument. This function is useful when you play this instrument along with other instruments or CD music. NOTE These settings will not be applied to the Drum Kit Voices or Audio Song. Also, these settings will not be recorded to a MIDI Song.	440.0 Hz (=A3)	414.8 Hz – 466.8 Hz (approx. 0.2 Hz steps)
	Scale Tune	(Setting display)	Modern acoustic pianos are tuned almost exclusively in equal temperament, which divides one octave into twelve equal intervals. Likewise, this digital piano employs equal temperament, but it can be changed at the touch of a button to play in historical temperaments used in the 16th to 19th centuries.	Equal	Refer to the "Scale Tune List" (page 89)
	Base Note	(Setting display)	Determines the base note for the Scale selected above. When the base note is changed, the pitch of the keyboard is transposed, yet maintains the original pitch relationship between the notes. This setting is necessary when Scale Tune is set to something other than "Equal Temperament." NOTE When Scale Tune is set to "Equal Temperament," "–" is shown on the display and this parameter cannot be edited.	C	C, C#, D, E♭, E, F, F#, G, A♭, A, B♭, B
Keyboard	Touch	(Setting display)	Determines how the sound responds to your playing strength. This setting does not change the weight of the keyboard. <ul style="list-style-type: none"> • Soft2: Produces relatively high volume even with light playing strength. Best for players with a light touch. • Soft1: Produces high volume with moderate playing strength. • Medium: Standard Touch Sensitivity. • Hard1: Requires moderately strong playing for high volume. • Hard2: Requires strong playing to produce high volume. Best for players with a heavy touch. • Fixed: No touch response. The volume level will be the same regardless of how hard you play the keys. NOTE The setting here will not be recorded to a MIDI Song and not be transmitted as MIDI messages.	Medium	Soft 2, Soft 1, Medium, Hard 1, Hard 2, Fixed
	Fixed Velocity	(Pop-up window)	Determines the velocity with which you play the keys when Touch (above) is set to "Fixed." NOTE The setting here will not be recorded to a MIDI Song and not be transmitted as MIDI messages.	64	1 – 127
	Duo	(Setting display)	Splits the keyboard into two ranges, allowing you to play duets over the same octave range (page 32).	Off	On, Off

To call up the desired parameter:

Press the [≡] (Menu) button several times to select "System" menu, then use the [△]/[▽]/[<]/[>] buttons to select the desired parameter.

[>] [<]	[>] [<]	[>] [<]	Description	Default setting	Setting range
Keyboard	Duo - Type	–	Selects the sound balance between the left and right speakers while Duo is on. <ul style="list-style-type: none"> • Separated: The sound of the Left section is output from the left speaker(s), and the sound of the Right section is output from the right speaker(s). • Balanced: The sounds played on the Right and Left sections are output through both speakers, with a natural balance of sound. 	Separated	Separated, Balanced
	Split Point	(Setting display)	Determines the Split Point (the boundary between the Right section and Left section).	E3	A–1 – C7
Pedal	Half Pedal Point	(Pop-up window)	Here you can specify the point to which you must depress the right pedal before the assigned effect begins to be applied. This setting applies only to the "Sustain Continuously" effect (page 80) that is assigned to the right pedal.	0	–2 (effective with the shallowest press) – 0 – +4 (effective with the deepest press)
	Soft Pedal Depth	(Pop-up window)	Determines how deeply the Soft pedal effect is applied. This parameter is available only for the pedal to which "Soft" (page 80) is assigned.	5	1 – 10
	Pitch Bend Range	(Pop-up window)	Determines the range of the pitch bend that is produced via the pedal in semitone steps. This setting is available only for the pedal to which "Pitch Bend Up" or "Pitch Bend Down" (page 80) is assigned. NOTE For some Voices, the pitch may not be changed according to the Pitch Bend Range value set here.	2	0 – +12 (pressing the pedal will raise/lower the pitch by 12 semitones [1 octave])
	Play/Pause	(Setting display)	Assigns the [PLAY/PAUSE] button's function to the Left pedal or the Center pedal. If a value other than "Off" is selected here, the corresponding pedal's function assigned in the "Voice" menu (page 79) is disabled.	Off	Off, Left, Center
Sound	Brilliance	(Setting display)	Adjusts the overall brilliance of sound for this instrument. You can also select "User" to make your own custom EQ settings. For details, refer to page 30.	Normal	Mellow 1 – 3, Normal, Bright 1 – 3, User
	IAC	–	Turns the IAC effect on or off. For details about IAC, refer to page 17.	On	On, Off
	IAC depth	(Pop-up window)	Determines the depth of the IAC. The higher the value, the more clearly the low/high sounds at lower volume levels.	0	–3 – +3
	Binaural	–	Turns the Binaural Sampling function (when headphones are connected) on or off. When the function is on and headphones are connected, the sound from this instrument changes to the sound of Binaural Sampling or the sound enhanced with the Stereophonic Optimizer, allowing you to enjoy more realistic sound (page 18). NOTE When the "Speaker" setting (page 88) is on, this function will always be disabled even when headphones are connected.	On	On, Off

To call up the desired parameter:

Press the [≡] (Menu) button several times to select “System” menu, then use the [△]/[▽]/[<]/[>] buttons to select the desired parameter.

[>] [<]	[>] [<]	[>] [<]	Description	Default setting	Setting range
MIDI	MIDI OUT	(Setting display)	Determines the MIDI channel on which the MIDI messages generated via the keyboard performance will be transmitted from the MIDI [OUT] or USB [TO HOST] terminal. When Duo is on, the MIDI channels are assigned as follows. <ul style="list-style-type: none"> • Performance on the Right section = n (setting value) • Performance on the Left section = n+1 	Ch1	Ch1 – Ch16, Off (not transmitted)
	MIDI IN	(Setting display)	Determines which part of the instrument will be controlled by each channel data of the MIDI messages coming from the MIDI [IN] and USB [TO HOST] terminal. <ul style="list-style-type: none"> • Song: Song part is controlled by the MIDI messages. • Keyboard: The entire keyboard is controlled regardless of the Duo setting. • R: When Duo is off, the entire keyboard is controlled. When Duo is on, the keyboard performance on the Right section is controlled. • L: When Duo is on, the keyboard performance on the Left section is controlled. • Off: No part is controlled. 	“Song” for each of all MIDI channels	For each MIDI channel: <ul style="list-style-type: none"> • Song • Keyboard • R • L • Off
	Local Control	–	“Local Control On” is a state in which this instrument produces the sound from its tone generator when you play the keyboard. In “Local Control Off” state, the keyboard and the tone generator are cut off from each other. This means that even if you play the keyboard, this instrument will produce no sound. Instead, the keyboard data can be transmitted via MIDI to a connected MIDI device or computer, which can produce the sound. The “Local Control Off” setting is useful when you wish to play only an external sound source while playing the keys on this instrument.	On	On, Off
	Receive Param.	(Setting display)	Determines which types of MIDI messages can be received or recognized by this instrument. <p>MIDI message types: Note on/off, Control Change, Program Change, Pitch Bend, System Exclusive</p>	On (for all the MIDI messages)	On, Off (for each MIDI message)
	Transmit Param.	(Setting display)	Determines which types of MIDI messages can be transmitted from this instrument. <p>MIDI message types: Note on/off, Control Change, Program Change, Pitch Bend, SystemRealTime, System Exclusive</p>	On (for all the messages)	On, Off (for each message)
	Initial Setup	Cancel	Transmits the current panel settings such as Voice selection to a connected MIDI device or computer. Before you start recording your performance to a connected MIDI device or computer, execute this operation to record the current panel settings at the beginning of your performance data. It causes that the same panel settings are called up when the recorded performance is played back. <p>Operation: Move the highlight to “Execute,” then press the [>] button to transmit the panel settings as MIDI messages.</p>	–	–
		Execute			
Backup	Backup Setting	–	For instructions about these functions, refer to pages 92–93.	–	–
	Backup	–			
	Restore	–			
	Factory Reset	–			

To call up the desired parameter:

Press the [≡] (Menu) button several times to select “System” menu, then use the [Δ]/[▽]/[◀]/[▶] buttons to select the desired parameter.

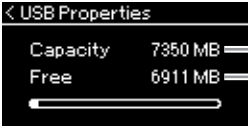
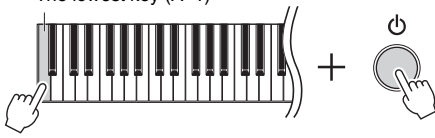
[▶] [◀]	[▶] [◀]	[▶] [◀]	Description	Default setting	Setting range
Utility	USB Format	Cancel	This lets you format or initialize the USB flash drive connected to the [USB TO DEVICE] terminal. NOTICE Executing the Format operation will delete all data saved in the USB flash drive. Save important data to a computer or another storage device. NOTE When connecting the USB flash drive to the [USB TO DEVICE] terminal, a message prompting you to execute the Format operation may appear. If such a case occurs, execute the Format operation.	–	–
		Execute	Operation Move the highlight to “Execute,” then press the [▶] button to start the Format operation. After Formatting is completed, a message appears then the instrument returns to the Utility display after a while. NOTICE Never turn off the power or disconnect the USB flash drive while “Executing” is shown in the display.	–	–
	USB Properties	– Shows the amount of free space and entire memory in the USB flash drive connected to the [USB TO DEVICE] terminal.  Amount of entire memory Amount of free space	–	–	
	USB Autoload	– When this is set to “On,” the Song saved in the root directory can be selected (shown on the display) automatically as soon as the USB flash drive is connected to the [USB TO DEVICE] terminal.	Off	On, Off	
	Speaker	(Setting display) Lets you switch the speaker on/off. • Normal: The speaker will sound only if headphones are not connected. • On: The speaker will always sound. • Off: The speaker will not sound. NOTE When this setting is on, “Binaural” (page 86) will always be disabled.	Normal	Normal, On, Off	
	Contrast	(Pop-up window) Adjusts the contrast of the display.	0	–5 – +5	
	Auto Power Off	(Setting display) Lets you set the amount of time that elapses before the power is turned off by Auto Power Off function (page 16). To disable Auto Power Off, select “Off.” Disabling Auto Power Off The lowest key (A-1)  Turn the power on while holding down the lowest key on the keyboard. A message appears briefly and Auto Power Off is disabled.	30 (minutes)	Off, 5, 10, 15, 30, 60, 120 (minutes)	
Audio Loopback	– Determines whether audio input from the connected computer or smart device is output to a computer or a smart device or not (page 66).	On	On, Off		

To call up the desired parameter:																																																																																																																									
Press the [≡] (Menu) button several times to select "System" menu, then use the [△]/[▽]/[<]/[>] buttons to select the desired parameter.																																																																																																																									
[>] [<]	[>] [<]	[>] [<]	Description	Default setting	Setting range																																																																																																																				
Utility	Version	–	Displays the model name and the firmware version of this instrument.	–	–																																																																																																																				
	Auto Backlight Off	(Setting display)	Lets you set the time that elapses until the control panel and the display turn off, or lets you set them to remain on indefinitely (the "Off" setting).	10 (seconds)	Off, 10, 20, 30, 60 (seconds)																																																																																																																				
	Touch Panel Sound	–	Determines whether a sound is made when the control panel is operated (the "on" setting), or whether no sound is heard (the "off" setting).	On	On, Off																																																																																																																				
	Language	System Song	Determines the type of characters shown on the display for the System (general indication other than Song name) and Song (Song name) individually. Character list: International <table border="1" style="font-family: monospace; border-collapse: collapse; text-align: center;"> <tr><td>0~9</td><td>A~Z</td><td>a~z</td><td>Ä</td><td>Ë</td><td>Ï</td><td>Ö</td><td>Ü</td><td>ä</td><td>ë</td><td>ï</td><td>ö</td><td>ü</td><td>à</td><td>è</td><td>ì</td><td>ò</td></tr> <tr><td>ù</td><td>á</td><td>é</td><td>í</td><td>ó</td><td>ú</td><td>â</td><td>ê</td><td>î</td><td>ô</td><td>û</td><td>ñ</td><td>ñ</td><td>Ç</td><td>ç</td><td>°</td><td>ı</td><td>¿</td><td>!</td><td>#</td><td>\$</td></tr> <tr><td>%</td><td>&</td><td>'</td><td>(</td><td>)</td><td>+</td><td>,</td><td>-</td><td>;</td><td>=</td><td>@</td><td>[</td><td>]</td><td>^</td><td>`</td><td>{</td><td>}</td><td>~</td><td>.</td><td></td><td></td></tr> </table> Japanese <table border="1" style="font-family: monospace; border-collapse: collapse; text-align: center;"> <tr><td>0~9</td><td>A~Z</td><td>a~z</td><td>ア</td><td>ン</td><td>ア</td><td>オ</td><td>ヤ</td><td>ユ</td><td>ヨ</td><td>ツ</td><td>ッ</td><td>°</td><td>ー</td><td>。</td></tr> <tr><td>「</td><td>」</td><td>,</td><td>.</td><td>!</td><td>#</td><td>\$</td><td>%</td><td>&</td><td>'</td><td>(</td><td>)</td><td>+</td><td>,</td><td>-</td><td>;</td><td>=</td><td>@</td><td>[</td><td>]</td><td>^</td></tr> <tr><td>_</td><td>{</td><td>}</td><td>~</td><td>.</td><td></td><td></td><td></td><td></td><td></td><td></td><td></td><td></td><td></td><td></td><td></td><td></td><td></td><td></td><td></td><td></td></tr> </table>	0~9	A~Z	a~z	Ä	Ë	Ï	Ö	Ü	ä	ë	ï	ö	ü	à	è	ì	ò	ù	á	é	í	ó	ú	â	ê	î	ô	û	ñ	ñ	Ç	ç	°	ı	¿	!	#	\$	%	&	'	()	+	,	-	;	=	@	[]	^	`	{	}	~	.			0~9	A~Z	a~z	ア	ン	ア	オ	ヤ	ユ	ヨ	ツ	ッ	°	ー	。	「	」	,	.	!	#	\$	%	&	'	()	+	,	-	;	=	@	[]	^	_	{	}	~	.																	International	Japanese, International
	0~9	A~Z	a~z	Ä	Ë	Ï	Ö	Ü	ä	ë	ï	ö	ü	à	è	ì	ò																																																																																																								
ù	á	é	í	ó	ú	â	ê	î	ô	û	ñ	ñ	Ç	ç	°	ı	¿	!	#	\$																																																																																																					
%	&	'	()	+	,	-	;	=	@	[]	^	`	{	}	~	.																																																																																																							
0~9	A~Z	a~z	ア	ン	ア	オ	ヤ	ユ	ヨ	ツ	ッ	°	ー	。																																																																																																											
「	」	,	.	!	#	\$	%	&	'	()	+	,	-	;	=	@	[]	^																																																																																																					
_	{	}	~	.																																																																																																																					
Wireless LAN			These parameters are shown only when the USB wireless LAN adaptor UD-WL01 (sold separately) is connected to the [USB TO DEVICE] terminal on this instrument. For details, refer to page 90.																																																																																																																						
Wireless LAN Option																																																																																																																									

■ Scale Tune List (Temperament List)

Equal (Equal Temperament)	One octave is divided into twelve equal intervals. Currently most popular piano tuning scale.
PureMajor/PureMinor	Based on natural overtones, three major chords using these scales produce a beautiful, pure sound.
Pythag. (Pythagorean)	This scale was devised by Pythagoras, the famous Greek philosopher and is created from a series of perfect fifths, which are collapsed into a single octave. The 3rd in this tuning is slightly unstable, but the 4th and 5th are beautiful and suitable for some leads.
MeanTone	This scale was created as an improvement on the Pythagorean scale, by making the major third interval more "in tune." It was especially popular from the 16th century to the 18th century. Handel, among others, used this scale.
Werck. (Werckmeister)/Kirnberger	These scales combine Mean Tone and Pythagorean in different ways. With these scales, modulation changes the impression and feel of the Songs. They were often used in the era of Bach and Beethoven. They are also often used now to reproduce the music of that era on harpsichords.

Wireless LAN Settings

The following parameters are shown only when the USB wireless LAN adaptor UD-WL01 (sold separately) is connected to the [USB TO DEVICE] terminal on this instrument. For details on setting procedures, refer to page 71.

* "Wireless LAN" parameters differ depending on the "Wireless LAN Mode" setting ("Infrastructure" or "Accesspoint"). By default, it is set to "Infrastructure."

To call up the desired parameter:

Press the [≡] (Menu) button several times to select "System" menu, then use the [△]/[▽]/[<]/[>] buttons to select the desired parameter.

[>] [<]	[>] [<]	[>] [<]	[>] [<]	[>] [<]	Description	Default setting	Setting range
Utility	Wireless LAN* (In the "Infrastructure" mode)	Select Network	(Networks)		Connect to an access point by selecting the network.	–	–
			Other	SSID	Set the SSID.	–	Up to 32 characters (half size), alphanumeric characters, marks
				Security	Set the Security.	NONE	NONE, WEP, WPA-PSK (TKIP), WPA-PSK (AES), WPA2-PSK (AES), WPA/WPA2 mixed PSK
				Password	Set the Password.	–	Up to 64 characters (half size), alphanumeric characters, marks
				Connect	Connect using the settings in "Other" display.	–	–
		Detail	DHCP		Set the wireless LAN detailed settings. IP Address, Subnet Mask, Gateway, DNS Server1, DNS Server2 can be set when DHCP is set to Off while cannot be set when DHCP set to On. Use the [<]/[>] buttons to select each octet in the entry display, then enter the value using the [△]/[▽] buttons. To finalize the setting, press the [≡] (Menu) button.	On	On/Off
			IP Address			0.0.0.0	0.0.0.0-255.255.255.255
			Subnet Mask			0.0.0.0	0.0.0.0-255.255.255.255
			Gateway			0.0.0.0	0.0.0.0-255.255.255.255
			DNS Server1			0.0.0.0	0.0.0.0-255.255.255.255
	DNS Server2			0.0.0.0	0.0.0.0-255.255.255.255		
	Save		Save the settings in the "Detail" display. Move the highlight to "Save," then press the [>] button to execute the Saving.	–	–		
	Wireless LAN* (In the "Accesspoint" mode)	SSID		Set the SSID as an access point.	ap-[NU1XA]-[xxxxxx (MAC address lower 6 figure)]	Up to 32 characters (half size), alphanumeric characters, marks	
		Security		Set the Security as an access point.	WPA2-PSK (AES)	NONE, WEP, WPA-PSK (TKIP), WPA-PSK (AES), WPA2-PSK (AES), WPA/WPA2 mixed PSK	
Password		Set the Password as an access point.	00000000	Up to 64 characters (half size), alphanumeric characters, marks			

To call up the desired parameter:

Press the [≡] (Menu) button several times to select “System” menu, then use the [△]/[▽]/[<]/[>] buttons to select the desired parameter.

[>] [<]	[>] [<]	[>] [<]	[>] [<]	[>] [<]	Description	Default setting	Setting range
Utility	Wireless LAN* (In the “Accesspoint” mode)	Channel			Set the channel as an access point.	11	Differs depending on the USB wireless LAN adaptor models. • Models for United States and Canada: 1 – 11 • Others: 1 – 13 When no USB wireless LAN adaptor is connected, setting range is channels 1 – 13.
		DHCP Server			Set the IP address related settings.	On	On, Off
		IP Address				192.168.0.1	192. 168. 0-255. 1-254.
		Subnet Mask				255.255.255.0	255.255.0.0, 255.255.128.0, 255.255.192.0, 255.255.224.0, 255.255.240.0, 255.255.248.0, 255.255.252.0, 255.255.254.0, 255.255.255.0
		Save			Save the settings you set in the Wireless LAN display (in the “Accesspoint” mode)	–	–
Wireless LAN Option	Wireless LAN Mode	Infrastructure Mode			Determines whether the access point is used for wireless LAN connection (Infrastructure Mode) or not (Accesspoint Mode).	Infrastructure Mode	–
		Accesspoint Mode					
	Initialize	Cancel			Initialize the settings in the wireless LAN display. Move the highlight to “Execute,” then press the [>] button to execute the initialization.	Cancel	–
		Execute					
	Detail	Host Name			Set the Host name.	[NU1XA]- [xxxxxx (MAC address lower 6 figure)]	Up to 57 characters (half size) including alphanumeric characters, the “_” (underscore) and “-” (hyphen) character.
		Mac Address			Display the MAC address of the USB wireless LAN adaptor.	–	–
		Status			Display the error code of network function.	–	–

■ Backup Setting

(Selecting parameters maintained even when the power is turned off)

This lets you set whether some settings of the Backup Setting (below) are maintained or not when the power is turned off. The Backup Setting consists of two groups, "Voice" (including Voice related settings such as Voice selection) and "Other" (including various settings such as Song Repeat and Tuning), which can be set individually.

Data and settings maintained even when the power is turned off

- User MIDI Song (saved in this instrument's "User" memory)
- System menu (page 85)
Bluetooth On/Off *
Keyboard (Duo Type only)
Utility
- Backup Setting (explained here)

* For information on whether Bluetooth functionality is included with the instrument or not, refer to page 67.

- 1 Press the [≡] (Menu) button several times to select the "System" menu (page 76).
- 2 Use the [Δ]/[▽] buttons to select "Backup," use the [▷] button to call up the next display, then use the [Δ]/[▽] buttons to select "Backup Setting."
- 3 Use the [▷] then the [Δ]/[▽] buttons to select "Voice," then use the [▷] button to select "On" or "Off."
The "Voice" selection here contains the following settings:
 - Voice selection
 - All the parameters other than Transpose in the "Voice" menu
- 4 Use the [Δ]/[▽] buttons to select "Other," then use the [▷] button to select "On" or "Off."
The "Other" selection here contains the following settings:
 - Split point
 - In the "Song" menu: Song Repeat, Volume (Song-Keyboard), Audio Volume, Quick Play, Play Track
 - In the "Metronome" menu: Volume, BPM, Bell On/Off
 - In the "System" menu: Tuning, Keyboard (except "Duo" and "Duo Type"), Pedal, Sound, MIDI
- 5 Press the [↵] (Exit) button to exit from the "System" menu.

■ Backup

(Saving the Backup file for internal data)

This lets you save data on internal memory to the connected USB flash drive as a backup file (named "NU1XA.bup"). This backup file can be loaded to the instrument via the Restore function (page 93) for future.

NOTICE

- It may take 1 – 2 minutes to complete this operation. Never turn off the power during this operation (while "Executing" is shown).
- If the same backup file (NU1XA.bup) is already saved in the USB flash drive, this operation will overwrite or replace this file with new one.

- 1 Connect the USB flash drive to the [USB TO DEVICE] terminal.
- 2 Press the [≡] (Menu) button several times to select the "System" menu (page 76).
- 3 Use the [Δ]/[▽] buttons to select "Backup," use the [▷] button to call up the next display, then use the [Δ]/[▽] buttons to select "Backup."
- 4 Use the [▷] button to call up the next display, then use the [Δ]/[▽] buttons to select "Execute."
- 5 Press the [▷] button to execute the Backup operation.
- 6 Press the [↵] (Exit) button to exit from the "System" menu.

NOTE

When you want to restore the settings in the backup file, execute the Restore function (page 93).

■ Restore

(Restarting the instrument with the Backup file loaded)

This lets you load the backup file (NU1XA.bup) saved via the Backup function (page 92) to the instrument on.

NOTICE

- It may take 1 – 2 minutes to complete this operation. Never turn off the power during this operation (while “Executing” is shown). Doing so could result in damage to the data.
- If recorded Songs reside on “User” memory, make sure to move the Songs to the USB flash drive by following the instructions page 60 before executing this operation. If you do not, the Songs will be deleted via this operation.

- 1 Connect the USB flash drive containing the Backup file to the [USB TO DEVICE] terminal.
- 2 Press the [≡] (Menu) button several times to select the “System” menu (page 76).
- 3 Use the [Δ]/[▽] buttons to select “Backup,” use the [▷] button to call up the next display, then use the [Δ]/[▽] buttons to select “Restore.”
- 4 Use the [▷] button to call up the next display, then use the [Δ]/[▽] buttons to select “Execute.”
- 5 Press the [▷] button to execute the Restore operation.

A message indicating that the operation is completed appears, then the instrument will restart after a while.

■ Factory Reset

(Restarting the instrument with the initial factory settings loaded)

This lets you reset this instrument to its factory default settings which refers to the initial setting preprogrammed when shipped from the factory, and is called up when you first turn on the power to this instrument.

Note that the following points.

- This operation resets the Backup Setting (page 92) to the default setting.
- This operation will not delete the Songs saved in the User folder.
- This operation will not delete the Bluetooth* pairing information (page 68).

* For information on whether Bluetooth functionality is included with the instrument or not, refer to page 67.

NOTICE

Never turn off the power during this operation (while “Factory reset executing” is shown). Doing so could result in damage to the data.

- 1 Press the [≡] (Menu) button several times to select the “System” menu (page 76).
- 2 Use the [Δ]/[▽] buttons to select “Backup,” use the [▷] button to call up the next display, then use the [Δ]/[▽] buttons to select “Factory Reset.”
- 3 Use the [▷] button to call up the next display, then use the [Δ]/[▽] buttons to select “Execute.”
- 4 Press the [▷] button to execute the Restore operation.

A message indicating that the operation is completed appears, then the instrument will restart after a while.

• Alternate method for restoring the default settings

Press and hold down the white key on the right end (C7) and press the [⏻] (Standby/On) switch to turn on the power to this instrument. This operation will not delete any Songs in the User folder or the Bluetooth pairing information.

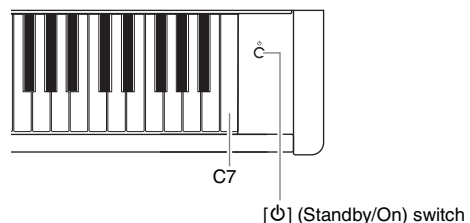

Appendix

Voice List

Voice Group	Voice Name	Stereo Sampling	Touch Sensitivity	Key-Off Sampling	Voice description
PIANO	CFX Grand	○	○	○	Yamaha's CFX concert grand piano sound with a wide dynamic range for maximum expressive control. Suitable for playing in any music genre and style. When this Voice is selected, connecting the headphones automatically enables binaural sampling sound.
	Bösendorfer	○	○	○	The famed sound of the Vienna-made Bösendorfer Imperial concert grand piano. Its spacious sound evokes the size of the instrument, and is ideal for expressing tenderness in compositions. When this Voice is selected, connecting the headphones automatically enables binaural sampling sound.
	Studio Grand	○	○	○	The sound of Yamaha's C7 grand piano, which is often used in recording studios. Its bright and clear sound is good for popular styles.
	Ballad Grand	○	○	○	Grand piano sound with a soft and warm tone. Good for playing ballads.
	Pop Grand	○	○	○	A slightly brighter piano sound. Good for popular styles.
	Upright Piano	○	○	×	The sound sampled from an upright piano, the Yamaha SU7. Enjoy the unique tonal character and a lighter, more casual feel.
FORTEPIANO	Scarlatti Piano	○	○	○	The sound of a piano made by a musical instrument maker in Florence in the early 18th century. The maker is famous for inventing the piano. It is believed that Scarlatti used the piano made by the maker. The sound is bright and brilliant.
	Mozart Piano	○	○	×	The sound of a piano made by a musical instrument maker in Vienna in the late 18th century. Mozart and Beethoven played and highly appreciated the piano made by this manufacturer. Its sound is clear and light.
	Beethoven Piano	○	○	○	The sound of a piano made by a piano manufacturer in London in the early 19th century. Haydn and Beethoven composed many masterpieces inspired by the pianos of this manufacturer. It features a rich bass, sparkling highs and energetic fortissimo.
	Chopin Piano	○	○	×	The sound of a piano made by a piano manufacturer in Paris in the 19th century. Chopin deeply loved the pianos of this manufacturer, which responded well to his sensitive touch. It has a sound like a singing voice, sometimes luscious, sometimes mournful.
E.PIANO	Stage E.Piano	×	○	○	The sound of an electric piano using hammer-struck metallic "tines." Soft tone when played lightly, and an aggressive tone when played hard.
	DX E.Piano	×	○	×	An electronic piano sound produced by an FM synthesizer. The tone will change as you vary your playing touch. Ideal for popular music.
	Vintage EP	×	○	○	The sound of an electric piano using hammer-struck metal reeds. Widely used in rock and popular music.
	Soft EP	×	○	○	An electric piano with a characteristic panning effect. Good for playing quiet ballads.
LAYER	Piano + Strings	○	○	○	Combination of piano and strings ensemble Voices, giving you a richly textured sound as if you were playing the piano with orchestral accompaniment.
	Piano + Pad	○	○	○	Combination of piano and Synth Pad Voices.
	Piano + DX EP	○	○	○	Combination of piano and DX E. Piano Voices.

Voice Group	Voice Name	Stereo Sampling	Touch Sensitivity	Key-Off Sampling	Voice description
ORGAN	Organ GrandJeu	○	×	×	A registration sound famous for use in French organ compositions. This dramatic sound is ideal for ending a performance.
	Organ Principal	○	×	×	This Voice features the combination of pipes (8'+4'+2') of a principal (brass instrument) organ. It is suitable for Baroque church music.
	Organ Tutti	○	×	×	This Voice features a full coupler of a pipe organ, famous for the sound used in Toccata and Fugue by Bach.
	Jazz Organ	×	×	×	The sound of an electric organ often heard in jazz and rock idioms. Pressing the left pedal switches the speed of Rotary Speaker effect between slow and fast.
OTHERS	Harpsichord 8'	○	×	○	The sound of the instrument frequently used in baroque music. Variations in playing touch will not affect the volume, and a characteristic sound will be heard when you release the key.
	Harpsi. 8'+4'	○	×	○	A harpsichord with an added upper octave. Produces a more brilliant sound.
	Celesta	○	○	×	The sound of a celesta (a percussion instrument in which hammers strike metallic bars to produce sound). This instrument is well-known for its appearance in "Dance of the Sugar-plum Fairies" from Tchaikovsky's "Nutcracker Suite."
	Vibraphone	○	○	×	A Vibraphone sound, sampled in stereo. Its spacious and clear sound is ideal for popular music. Pressing the left pedal switches Vibrato on and off.
	Marimba	○	○	×	A marimba sound, sampled in stereo for spaciousness and realism.
	Harp	×	○	×	This sound was sampled from a grand harp. This sound, with a bright attack, is ideal for playing gorgeous phrases.
	Strings	○	○	×	The sound of large-scale strings ensemble, with a slow attack.

Key-off Sampling

Samples of the very delicate noises that are produced when keys are released.

NOTE

- VRM is effective only for Voices in the Piano group. For details about VRM, refer to page 25.
- Grand Expression Modeling is effective only for the Voices of "CFX Grand" and "Bösendorfer." For details about Grand Expression Modeling, refer to page 25.

Voice Demo Song List

Voice Group	Voice Name	Song Name	Composer
PIANO	CFX Grand	Etude op.10-10 As dur	F. F. Chopin
	Bösendorfer	Widmung, S. 566, R. 253	F. Liszt
	Studio Grand	Original	–
	Ballad Grand	Original	–
	Pop Grand	Original	–
	Upright Piano	Italienisches Konzert, BWV.971-1 1st mov.	J. S. Bach
FORTEPIANO	Scarlatti Piano	Sonata G dur K.14 L.387	D. Scarlatti
	Mozart Piano	Sonata No.15 C dur K.545 1st mov.	W. A. Mozart
	Beethoven Piano	Für Elise a moll	L. v. Beethoven
	Chopin Piano	Nocturne op.27-2 Des dur	F. F. Chopin
E.PIANO	Stage E.Piano	Original	–
	DX E.Piano	Original	–
	Vintage EP	Original	–
	Soft EP	Original	–
LAYER	Piano + Strings	Original	–
	Piano + Pad	Original	–
	Piano + DX EP	Original	–
ORGAN	Organ GrandJeu	Original	–
	Organ Principal	Herr Christ, der ein'ge Gottes-Sohn, BWV 601	J. S. Bach
	Organ Tutti	Original	–
	Jazz Organ	Original	–
OTHERS	Harpsichord 8'	Concerto a cembalo obbligato, 2 violini, viola e continuo No.7 g moll BWV 1058 1st mov.	J. S. Bach
	Harpsichord 8'+4'	Gigue, French Suite No. 5, BWV 816	J. S. Bach
	Celesta	Dance of the Sugar Plum Fairy	P. I. Tchaikovsky
	Vibraphone	Original	–
	Marimba	Study in A minor	Georges Pheiffer
	Harp	Original	–
	Strings	Original	–

The Demo Songs excluding original Songs are short rearranged excerpts from the original compositions. The original Demo Songs are Yamaha originals (© Yamaha Corporation).

Song List

50 Classical

No.	Song Title	Composer
Arrangements		
1	Canon D dur	J. Pachelbel
2	Air On the G String	J. S. Bach
3	Jesus, Joy of Man's Desiring	J. S. Bach
4	Twinkle, Twinkle, Little Star	Traditional
5	Piano Sonata op.31-2 "Tempest" 3rd mov.	L. v. Beethoven
6	Ode to Joy	L. v. Beethoven
7	Wiegenlied op.98-2	F. P. Schubert
8	Grande Valse Brillante	F. F. Chopin
9	Polonaise op.53 "Héroïque"	F. F. Chopin
10	La Campanella	F. Liszt
11	Salut d'amour op.12	E. Elgar
12	From the New World	A. Dvořák
13	Sicilienne	G. U. Fauré
14	Clair de lune	C. A. Debussy
15	Jupiter (The Planets)	G. Holst
Duets		
16	Menuett (Eine kleine Nachtmusik K.525)	W. A. Mozart
17	Menuett G dur	L. v. Beethoven
18	Marcia alla Turca	L. v. Beethoven
19	Piano Concerto No.1 op.11 2nd mov.	F. F. Chopin
20	The Nutcracker Medley	P. I. Tchaikovsky
Original Compositions		
21	Prelude (Wohltemperierte Klavier I No.1)	J. S. Bach
22	Menuett G dur BWV Anh.114	J. S. Bach
23	Piano Sonata No.15 K.545 1st mov.	W. A. Mozart
24	Turkish March	W. A. Mozart
25	Piano Sonata op.13 "Pathétique" 2nd mov.	L. v. Beethoven
26	Für Elise	L. v. Beethoven
27	Piano Sonata op.27-2 "Mondschein" 1st mov.	L. v. Beethoven
28	Impromptu op.90-2	F. P. Schubert
29	Frühlingslied op.62-6	J. L. F. Mendelssohn
30	Fantaisie-Impromptu	F. F. Chopin
31	Etude op.10-3 "Chanson de l'adieu"	F. F. Chopin
32	Etude op.10-12 "Revolutionary"	F. F. Chopin
33	Valse op.64-1 "Petit chien"	F. F. Chopin
34	Nocturne op.9-2	F. F. Chopin
35	Nocturne KK4a-16/BI 49 [Posth.]	F. F. Chopin
36	Träumerei	R. Schumann
37	Barcarolle	P. I. Tchaikovsky
38	La prière d'une Vierge	T. Badarzewska
39	Liebesträume No.3	F. Liszt
40	Blumenlied	G. Lange
41	Humoresque	A. Dvořák
42	Arietta	E. H. Grieg
43	Tango (España)	I. Albéniz
44	The Entertainer	S. Joplin
45	Maple Leaf Rag	S. Joplin
46	La Fille aux Cheveux de Lin	C. A. Debussy
47	Arabesque No.1	C. A. Debussy
48	Cakewalk	C. A. Debussy
49	Je te veux	E. Satie
50	Gymnopédies No.1	E. Satie

Lesson Songs

Album Title	No. /Song Title	Composer	
Vorschule im Klavierspiel op.101	1-106	F. Beyer	
25 Etudes faciles et progressives op.100	1	La candeur	J. F. Burgmüller
	2	Arabesque	
	3	Pastorale	
	4	Petite réunion	
	5	Innocence	
	6	Progrès	
	7	Courant limpide	
	8	La gracieuse	
	9	La chasse	
	10	Tendre fleur	
	11	La bergeronnette	
	12	Adieu	
	13	Consolation	
	14	La styrienne	
	15	Ballade	
	16	Douce plainte	
	17	Babilarde	
	18	Inquiétude	
	19	Ave Maria	
	20	Tarentelle	
	21	Harmonie des anges	
	22	Barcarolle	
	23	Retour	
	24	L'hirondelle	
	25	La chevaleresque	
100 Übungsstücke op.139	1-100	C. Czerny	
30 Etudes de mécanisme op.849	1-30	C. Czerny	
The Virtuoso Pianist	1-20 1-Variation. 1-22	C-L. Hanon	

About Duet Songs

The songs listed below are duet songs.

- Nos.16-20 of "50 Classical"
- Nos. 1-11 of the Vorschule im Klavierspiel op.101 of "Lesson Songs" as well as 32-34, 41-44, 63-64, and 86-87

The right-hand part is for the right hand of the first player, the left-hand part is for the left hand of the first player, and Extra part is for the both hands of the second player.

Message List

Some message display remains open. In this case, press the [↵] (Exit) button to close message display.

Message	Meaning
Access error	The operation has failed. The following causes can be considered. If the following are not responsible, the file may be damaged. <ul style="list-style-type: none"> The file operation is wrong. Follow the instructions in "Handling Song Files" (page 57) or "Backup"/ "Restore" (pages 92 –93). The connected USB flash drive is not compatible with this instrument. For information on compatible USB flash drive, see page 64.
Bluetooth pairing...	The instrument is standing by for Bluetooth pairing. Refer to the instructions on page 68.
Cannot be executed	The operation has failed. The following causes can be considered. Solve the causes, and try again. <ul style="list-style-type: none"> The file operation you attempted cannot be executed to Preset Songs or an Audio Song. For information on the limitation of handling Song files, see page 57. The Song file operation cannot be made to an empty Song file (page 47) or NoSong. NoSong: This is displayed when you select a folder which does not contain any Songs.
Change to Current Tempo	This message indicates that you are applying the current tempo to the selected Song.
Change to Current Voice	This message indicates that you are changing the Voice of the Song with the current Voice.
Completed	This message indicates that the operation is completed. Go on to the next step.
Completed Restart now	Restore is completed. The instrument is automatically turned on again.
Convert canceled	This message appears when the convert operation is canceled.
Convert completed to USB/ USERFILES/	This message appears when the convert operation to the "USER FILES" folder on a USB flash drive is completed.
Convert to Audio	This message appears during the convert operation.
Copy completed to USB/ USERFILES/	This message appears when the copy operation to the "USER FILES" folder on a USB flash drive is completed.
Copy completed to User	This message appears when the copy operation to the "User" on this instrument is completed.
Device busy	The operation, such as converting to the Audio Song or Audio Song playback/recording, has failed. This message appears when you attempt to use a USB flash drive to which recording/deleting operations are repeated. Execute the Format operation after making sure there is no important data in the USB flash drive (page 88), and try again.
Device removed	This message appears when the USB flash drive is removed from the instrument.
Duplicate name	This message indicates that an identically named file already exists. Rename the file (page 61).
Executing	The instrument is executing the operation. Wait until the message disappears, then go on to the next step.
Factory reset executing Memory Song excluded	The default settings (except the Songs in the "User") have been restored (page 93). This message also appears if you press and hold down the C7 key and turn on the power to the instrument.
Factory reset Completed Restart	Factory reset is completed. The instrument is then restarted.
Incompatible device	This message appears when an incompatible USB flash drive is connected. Use a device whose compatibility has been confirmed by Yamaha (page 64).
Internal hardware error	A malfunction has occurred in the instrument. Contact your nearest Yamaha dealer or authorized distributor.
Last power off invalid Checking memory	This message appears when the power is turned on after turning off the power while handling a Song file (page 57) or saving a backup file (page 92). The internal memory is being checked while this message appears. If the internal settings are damaged, they will be reset to the default settings. If the Songs in the "User" are damaged, they will be deleted.
Maximum no. of devices exceeded	The number of devices exceed the limitation. Only one USB device can be connected. For details, see page 64.
Memory full	Since the capacity and the number of files in the "User"/USB flash drive are full, the operation cannot be completed. Delete some Songs in the "User"/USB flash drive or move Songs to another USB flash drive, and try again.
Move completed to USB/ USERFILES/	This message appears when the move operation to the "USER FILES" folder on a USB flash drive is completed.
Move completed to User	This message appears when the move operation to "User" on the instrument is completed.

Message	Meaning
No device	A USB flash drive was not connected to the instrument when you attempted to perform a device-related operation. Connect the device, and try again.
No response from USB device	The instrument cannot communicate with the connected USB device. Redo the connection (page 64). If you still see this message, the USB device may be damaged.
Please wait	The instrument is processing the data. Wait until the message disappears, then go on to the next step.
Protected device	This message appears when you attempt a file operation (page 57), record your performance or save the data on a read-only USB flash drive. Cancel the read-only setting, if possible, and try again. If you still see this message, the USB flash drive is internally protected (such as commercially available music data). You cannot make the file operation or record your performance to such a device.
Read-only file	You attempted a file operation to a read-only file. Read-only files have handling limitations (page 57), and cannot be used for editing (page 53). Use a read-only file after overriding the read-only setting.
Remaining space on drive is low	Since the remaining space on the "User"/USB flash drive is low, delete any unnecessary files (page 59) before recording.
Same file name exists	This message appears to prompt you to confirm if overwriting or not when executing a Copy/Move/MIDI to Audio operation.
Song error	This message appears, if a problem is found with the Song data when you select a Song or while the Song is playing. In this case, reselect the Song, and try again to play back. If the message still appears, the Song data may have been damaged.
Song too large	The size of Song data (MIDI/Audio) exceeds the limitation. The following causes can be considered. <ul style="list-style-type: none"> • The Song size you attempt to play back exceeds the limitation. The limitation for playback is approx. 500 KB (MIDI), 80 minutes (Audio). • The Song size exceeds the limitation during recording. The limitation for recording is approx. 500 KB (MIDI), 80 minutes (Audio). The recording will end automatically and the recorded data before the end is saved. • The Song size exceeds the limitation during converting a MIDI Song to an Audio Song. The limitation is 80 minutes (Audio).
System limit	This message appears when the number of files exceeds the system limit. The maximum number of files and folders which can be saved in a folder is 250. Try again after deleting/moving the unnecessary file(s).
This data format is not supported	This message appears when you attempted to load a Song of unsupported format to this instrument. Refer to the page 36 about supported Song formats.
Unformatted device	This message appears when you attempt to use an unformatted USB flash drive. Format it (page 88), and try again.
Unsupported device	This message appears when an unsupported USB flash drive is connected. Use a device whose compatibility has been confirmed by Yamaha (page 64).
USB device overcurrent error	Communication with the USB device has been cut off because of an abnormal power surge to the device. Disconnect the USB device from the [USB TO DEVICE] terminal and turn the [⏻] (Standby/On) switch of the instrument standby and on again.
Wrong device	The file operation cannot be made to the connected USB flash drive. The following causes can be considered. <ul style="list-style-type: none"> • The USB flash drive is not formatted. Format it (page 88), and try again. • The number of files exceeds the system limit. The maximum number of files and folders which can be saved in a folder is 250. Try again after deleting/moving the unnecessary file(s).
Wrong name	The Song name is not appropriate. This message appears during the "Renaming Song Files" (page 61) operation because of the following causes. Rename the Song correctly. <ul style="list-style-type: none"> • No character has been input. • You used a period or space at the beginning/ending of a Song name.

Troubleshooting

When a message is displayed, refer to the “Message List” (page 98) for troubleshooting aid.

Problem	Possible Cause and Solution
The instrument does not turn on.	The plugs are not properly connected. Make sure that the DC plug is securely inserted into the DC IN jack on the instrument, and that the AC plug is securely inserted to the AC outlet (page 15).
A click or pop is heard when the power is turned on or off.	This is normal when electrical current is being applied to the instrument.
The power is automatically turned off.	This is normal and due to the Auto Power Off function. If necessary, set the parameter of the Auto Power Off function (page 88).
The message “USB device overcurrent error” is shown and the USB device does not respond.	Communication with the USB device has been shut down because of the over-current to the USB device. Disconnect the device from the [USB TO DEVICE] terminal, then turn on the power of the instrument.
Noise is heard from the speakers or headphones.	The noise may be due to interference caused by the use of a mobile phone in close proximity to the instrument. Turn off the mobile phone, or use it further away from the instrument.
Noise is heard from the instrument’s speakers or headphones when using the instrument with your smart device, such as an iPhone/iPad.	When you use the instrument along with your smart device, we recommend that you enable “Airplane Mode” on the device to avoid noise caused by communication. When wirelessly connecting a smart device with this product, make sure that the Wi-Fi or Bluetooth setting on the device is turned on.
The overall volume is low, or no sound is heard.	The Master Volume is set too low; set it to an appropriate level using the [MASTER VOLUME] control (page 17).
	The volume level for the keyboard performance is set too low. Adjust the volume balance to increase the keyboard volume via the “Song” menu: “Volume” → “Song - Keyboard” (page 81).
	Headphones or adaptor plugs are connected when the Speaker setting is “Normal” (page 88). Disconnect the headphone plugs and the adaptor plugs.
	The Speaker setting is “Off.” Set the Speaker to “Normal” via the “System” menu: “Utility” → “Speaker” (page 88).
The speakers do not switch off when a pair of headphones is connected to the [PHONES] jack.	The Speaker setting is “Off.” Set the speaker setting to “Normal” via the “System” menu: “Utility” → “Speaker” (page 88).
	Local Control is “Off.” Set Local Control “On” via the “System” menu: “MIDI” → “Local Control” (page 87).
The keyboard volume is lower than the Song playback volume.	The volume level for the keyboard performance is set too low. Adjust the volume balance to increase the keyboard volume via the “Song” menu: “Volume” → “Song - Keyboard” (page 81).
The buttons do not respond.	While you are using a function, some buttons not used for the function are disabled. If the Song is playing, stop playback. Otherwise, press the [] (Exit) button to return to the Voice or Song display. Then, perform the desired operation.
Higher or lower notes do not sound correctly when the transpose or octave setting is made.	This instrument can cover the range of C -2 – G8 when you set the transposition or octave. If notes lower than C -2 are played, the sound is moved one octave higher. If notes higher than G8 are played, the sound is moved one octave lower.
Performance in Duo mode is not recorded, or the recorded track data is lost unexpectedly.	Switching to Duo mode in the middle of the Song is not recorded. Note that when Duo mode is active, the recording track for the Left section is automatically assigned (page 49). If the assigned track already has data, the data will be overwritten and deleted when you record.
Depending on the selected Voice, the keyboard sound in Duo mode may be output from only one speaker.	This is because the default pan setting differs depending on the Voice. Change “Duo-Type” from “Separated” to “Balanced” via the “System” menu (page 86), or adjust the “Pan” setting via the “Voice” menu (page 78).
The Song title is not correct.	The “Language” setting may be different than that is selected when you named the Song. Also, if the Song was recorded on another instrument, the title might be displayed incorrectly. Set the “Language” parameter (page 89) via the “System” menu: “Utility” → “Language” → “Song” to change the setting. However, if the Song was recorded on another instrument, changing the “Language” parameter setting may not resolve the problem.
Menu display cannot be called up.	When Song is being played back, menu display other than “Voice” menu and “Song” menu will not appear. Stop the Song by pressing the [PLAY/PAUSE] button. Also, in the recording ready mode, only “Recording” menu display will appear.
Metronome or MIDI Song goes out of tempo slightly when you play the keyboard.	This occurs infrequently when Grand Expression Modeling is set to “Dynamic.” If this happens, set Grand Expression Modeling to “Static” (page 25).

Problem	Possible Cause and Solution
The contents of the Wireless LAN is not shown in the display even though the USB wireless LAN adaptor is connected.	Disconnect the USB wireless LAN adaptor and connect it again.
The Bluetooth-equipped smart device cannot be paired with nor connected to the instrument.	Check the Bluetooth function of the smart device is activated. To connect the smart device and the instrument via Bluetooth, both devices need to be functional.
	The smart device and the instrument need to be paired so that the instrument receives audio data from the smart device via Bluetooth (page 68).
	In case there is a device (microwave oven, wireless LAN device, etc.) that outputs signals in the 2.4 GHz frequency band nearby, move this instrument away from the device that is emitting radio-frequency signals.

*For information on whether Bluetooth functionality is included or not, refer to page 67.

Specifications

Product Name		Hybrid Piano		
Size/Weight	Width	1,501 mm (59-1/8")		
	Height	1,024 mm (40-5/16")		
	Depth	462 mm (18-3/16")		
	Weight	108 kg (238 lb, 2 oz)		
Control Interface	Keyboard	Number of Keys	88 (A-1 – C7)	
		Type	Specialized Upright Piano Action for NU1XA	
		Key Surfaces – White	Acrylic resin	
		Touch Response	Hard2/Hard1/Medium/Soft1/Soft2/Fixed	
	Sensor System	System	Articulation sensor system	
		Key Sensors	Non-contact continuous detection electromagnetic inductive type	
		Hammer Sensors	Non-contact continuous detection electromagnetic inductive type	
	Pedal	Number of Pedals	3: Damper (with Half-pedal function), Sostenuto, Soft	
		GrandTouch Pedals	Yes (with GP Response Damper)	
		Assignable Functions	Sustain (Switch), Sustain Continuously, Sostenuto, Soft, Pitch Bend Up, Pitch Bend Down, Rotary Speed, Vibe Rotor, Song Play/Pause	
	Display	Type	Full Dots LCD	
		Size	128 × 64 dots	
		Language	English, Japanese	
	Panel	Type	Touch sensors	
		Language	English	
	Cabinet	Key Cover Style	Soft-Close Fallboard	Yes
Music Rest			Yes	
Voices	Tone Generation	Piano Sound	Yamaha CFX, Bösendorfer Imperial	
		Binaural Sampling	Yes ("CFX Grand" and "Bösendorfer" only)	
	Piano Effects	VRM	Yes	
		Grand Expression Modeling	Yes	
		Key-off Samples	Yes	
		Smooth Release	Yes	
	Polyphony (max.)		256	
	Preset	Number of Voices	28	
Effects	Types	Reverb	6 types	
		Chorus	3 types	
		Brilliance	7 types + User	
		Effect	12 types	
		Intelligent Acoustic Control (IAC)	Yes	
		Stereophonic Optimizer	Yes	
	Functions	Duo	Yes	
Songs (MIDI)	Preset	Number of Preset Songs	Voice Demo: 28 Classic: 50 Lesson: 303	
		Recording	Number of Songs	250
			Number of Tracks	16
	Data Capacity		Approx. 500 KB/Song	
	Format	Playback	SMF (Format 0, Format 1)	
		Recording	SMF (Format 0)	

Songs (Audio)	Recording Time (max.)		80 minutes/Song
	Format	Playback	.wav (44.1 kHz sample rate, 16-bit resolution, stereo)
		Recording	.wav (44.1 kHz sample rate, 16-bit resolution, stereo)
Functions	Overall Controls	Metronome	Yes
		Tempo Range	5 – 500
		Transpose	–12 – 0 – +12
		Tuning	414.8 – 440.0 – 466.8 Hz (approx. 0.2 Hz increments)
		Scale Type	7 types
		USB audio interface	44.1 kHz sample rate, 24-bit resolution, stereo
	Miscellaneous	Piano Room	Yes
Bluetooth (May not have this functionality depending on the country in which you purchased the product.)	Audio	Supported profile	A2DP
		Compatible codec	SBC
	MIDI		Comply with Bluetooth Low Energy MIDI Specification
	Bluetooth version		4.2
	Wireless output		Bluetooth Class 2
	Maximum communication distance		Approx. 10 m
	Radio Frequency		2401 – 2481 MHz
	Maximum output power (EIRP)		4 dBm
Type of modulation		GFSK	
Storage and Connectivity	Storage	Internal Memory	Total maximum size approx. 1.4 MB
		External Drives	USB flash drive
	Connectivity	DC IN	24 V
		Headphones	Standard stereo phone jack (× 2)
		MIDI	IN / OUT
		AUX IN	Stereo Mini
		AUX OUT	[L/L+R] [R]
		USB TO DEVICE	Yes
USB TO HOST	Yes		
Sound System	Amplifiers		(40 W + 45 W) × 2
	Speakers		(16 cm + 2.5 cm (dome) with Bidirectional Horn) × 2
Power Supply	AC Adaptor		PA-500 (Output: DC 24 V, 2.5 A)
	Power Consumption		47 W
	Auto Power Off		Yes
Included Accessories			<ul style="list-style-type: none"> • Owner's Manual (this book) • "50 Classical Music Masterpieces" music book • Online Member Product Registration • AC adaptor PA-500* • Power cord* • Felt key cover • Headphone hanger • Headphone hanger screws • Felt strip set • Bench* <p>*May not be included depending on your area. Check with your Yamaha dealer.</p>
Separately Sold Accessories (May not be available depending on your area.)			<ul style="list-style-type: none"> • Headphones (HPH-50/HPH-100/HPH-150) • AC adaptor (PA-500) • USB wireless LAN adaptor (UD-WL01)

The contents of this manual apply to the latest specifications as of the publishing date. To obtain the latest manual, access the Yamaha website then download the manual file. Since specifications, equipment or separately sold accessories may not be the same in every locale, please check with your Yamaha dealer.

Index

Numerics

50 Classical 37, 97

A

AB Repeat 42

AC adaptor 15

Accessories 9

Accesspoint Mode 71, 74, 91

Audio Loopback 66, 88

Audio Recording 46

Audio Song 36

Auto Backlight Off 89

Auto Power Off 16, 88

B

Backup 92

Backup Setting 92

Bell 84

Binaural Sampling 18

Bluetooth 67, 85

Body Resonance 24

Brightness 24

Brilliance 30

C

Chorus 31, 77

Chorus Type List 80

Computer 65

Computer-related Operations 9

Connectors 62

Contrast 88

Control panel 13

Convert 61

Copy 60

D

Damper Noise 25

Damper pedal 19

Damper Resonance 24

Delete 59

Demo 37

Detailed settings 76

Duo 32

Duplex Scale 25

Duplex Scale Resonance 24

E

Effect Type List 80

Effects 31

EQ 31

F

Factory Reset 93

Fallboard 14

Fast forward 39

G

GP Response Damper 19

Grand Expression 25

Grand Expression Modeling 25

H

Half Pedal Point 25

Half-pedal function 19

Headphones 17

I

Infrastructure Mode 71, 91

Initial Setup 87

Intelligent Acoustic Control (IAC) 17

L

Language 89

Lesson 37

Lesson Songs 97

Lid Position 24

Local Control 87

M

Master Tune 24

Master Volume 15, 17

Message List 98

Metronome 34

Metronome menu 84

MIDI 87

MIDI Recording 46

MIDI Reference 9

MIDI Song 36

MIDI terminals 65

Move (Song file) 60

Music Rest 14

N

Network 72

O

Octave 78

P

Part Cancel 40

Pedal 18, 86

Pedal Function List 80

Piano Room	23
Piano Setting	77
Power	15

R

Recording	46
Recording menu	84
Rename	61
Restore	93
Reverb	24, 29, 77
Reverb Depth	24
Reverb Type List	29
Rewind	39

S

Scale Tune	85
Smart device	67, 70
Smart Pianist	9, 70
Smart Pianist User Guide	9
Soft pedal	19
Song	36
Song List	97
Song menu	81
Song playback	37
Song Repeat	43
Sostenuto pedal	19
Sound	86
Speaker	88
Specifications	102
Standby/On	15
Stereophonic Optimizer	18
String Resonance	24
System menu	85

T

Tempo	34
Time Signature	35, 84
Touch	24, 85
Touch Panel Sound	89
Track	49
Transpose	77
Troubleshooting	100

U

USB	37
USB Audio Interface function	66
USB Autoload	88
USB flash drive	64
USB Format	88
USB Properties	88
User (Song)	37
Utility	88

V

Version	89
Voice	26
Voice Demo	28
Voice Demo Song List	96
Voice Edit	78
Voice List	94
Voice menu	77
Volume balance	44
VRM	24, 25

W

Wireless LAN	72, 89, 90
Wireless LAN Option	89
WPS	73

For models equipped with Bluetooth / Pour les modèles équipés de la fonctionnalité Bluetooth

For U.S.A.

This transmitter must not be co-located or operated in conjunction with any other antenna or transmitter.

(554-M01 FCC transmitter 01)

This equipment complies with FCC radiation exposure limits set forth for an uncontrolled environment and meets the FCC radio frequency (RF) Exposure Guidelines. This equipment has very low levels of RF energy that is deemed to comply without testing of specific absorption rate (SAR).

(554-M04 FCC portable 01)

For CANADA

This equipment complies with ISED radiation exposure limits set forth for an uncontrolled environment and meets RSS-102 of the ISED radio frequency (RF) Exposure rules as this equipment has very low levels of RF energy.

(0555-M05_ised_portable_en_01)

Cet équipement est conforme aux limites d'exposition aux rayonnements énoncées pour un environnement non contrôlé et respecte les règles d'exposition aux fréquences radioélectriques (RF) CNR-102 de l'ISDE puisque cet appareil a un niveau très bas d'énergie RF.

(0555-M05_ised_portable_fr_01)

This device contains licence-exempt transmitter(s)/receiver(s) that comply with Innovation, Science and Economic Development Canada's licence-exempt RSS(s). Operation is subject to the following two conditions:

1. This device may not cause interference.
2. This device must accept any interference, including interference that may cause undesired operation of the device.

(555-M13 ISED RSS en 01)

L'émetteur/récepteur exempt de licence contenu dans le présent appareil est conforme aux CNR d'Innovation, Sciences et Développement économique Canada applicables aux appareils radio exempts de licence. L'exploitation est autorisée aux deux conditions suivantes :

1. L'appareil ne doit pas produire de brouillage ;
2. L'appareil doit accepter tout brouillage radioélectrique subi, même si le brouillage est susceptible d'en compromettre le fonctionnement.

(555-M13 ISED RSS fr 01)

For Mexico

La operación de este equipo está sujeta a las siguientes dos condiciones: (1) es posible que este equipo o dispositivo no cause interferencia perjudicial y (2) este equipo o dispositivo debe aceptar cualquier interferencia, incluyendo la que pueda causar su operación no deseada.

(556-M02 MX operating condition 01)

For European Union and United Kingdom

EN	SIMPLIFIED EU DECLARATION OF CONFORMITY / SIMPLIFIED UK DECLARATION OF CONFORMITY
<p>Hereby, Yamaha Music Europe GmbH declares that the radio equipment type [NU1XA] is in compliance with Directive 2014/53/EU and the radio equipment regulations of UK. The full texts of the EU declaration of conformity and the UK declaration of conformity are available at the following internet address: https://europe.yamaha.com/en/support/compliance/doc.html</p>	
FR	DECLARATION UE DE CONFORMITE SIMPLIFIEE
<p>Le soussigné, Yamaha Music Europe GmbH, déclare que l'équipement radioélectrique du type [NU1XA] est conforme à la directive 2014/53/UE. Le texte complet de la déclaration UE de conformité est disponible à l'adresse internet suivante : https://europe.yamaha.com/en/support/compliance/doc.html</p>	
DE	VEREINFACHTE EU-KONFORMITÄTSERKLÄRUNG
<p>Hiermit erklärt Yamaha Music Europe GmbH, dass der Funkanlagentyp [NU1XA] der Richtlinie 2014/53/EU entspricht. Der vollständige Text der EU-Konformitätserklärung ist unter der folgenden Internetadresse verfügbar: https://europe.yamaha.com/en/support/compliance/doc.html</p>	
SV	FÖRENKLAD EU-FÖRSÄKRAN OM ÖVERENSSTÄMMELSE
<p>Härmed försäkrar Yamaha Music Europe GmbH att denna typ av radioutrustning [NU1XA] överensstämmer med direktiv 2014/53/EU. Den fullständiga texten till EU-försäkran om överensstämmelse finns på följande webbadress: https://europe.yamaha.com/en/support/compliance/doc.html</p>	
IT	DICHIARAZIONE DI CONFORMITÀ UE SEMPLIFICATA
<p>Il fabbricante, Yamaha Music Europe GmbH, dichiara che il tipo di apparecchiatura radio [NU1XA] è conforme alla direttiva 2014/53/UE. Il testo completo della dichiarazione di conformità UE è disponibile al seguente indirizzo Internet: https://europe.yamaha.com/en/support/compliance/doc.html</p>	
ES	DECLARACIÓN UE DE CONFORMIDAD SIMPLIFICADA
<p>Por la presente, Yamaha Music Europe GmbH declara que el tipo de equipo radioeléctrico [NU1XA] es conforme con la Directiva 2014/53/UE. El texto completo de la declaración UE de conformidad está disponible en la dirección Internet siguiente: https://europe.yamaha.com/en/support/compliance/doc.html</p>	
PT	DECLARAÇÃO UE DE CONFORMIDADE SIMPLIFICADA
<p>O(a) abaixo assinado(a) Yamaha Music Europe GmbH declara que o presente tipo de equipamento de rádio [NU1XA] está em conformidade com a Diretiva 2014/53/UE. O texto integral da declaração de conformidade está disponível no seguinte endereço de Internet: https://europe.yamaha.com/en/support/compliance/doc.html</p>	
NL	VEREENVOUDIGDE EU-CONFORMITEITSVERKLARING
<p>Hierbij verklaar ik, Yamaha Music Europe GmbH, dat het type radioapparatuur [NU1XA] conform is met Richtlijn 2014/53/EU. De volledige tekst van de EU-conformiteitsverklaring kan worden geraadpleegd op het volgende internetadres: https://europe.yamaha.com/en/support/compliance/doc.html</p>	
BG	ОПРОСТЕНА ЕС ДЕКЛАРАЦИЯ ЗА СЪОТВЕТСТВИЕ
<p>С настоящото Yamaha Music Europe GmbH декларира, че този тип радиосъоръжение [NU1XA] е в съответствие с Директива 2014/53/ЕС. Цялостният текст на ЕС декларацията за съответствие може да се намери на следния интернет адрес: https://europe.yamaha.com/en/support/compliance/doc.html</p>	
CS	ZJEDNODUŠENÉ EU PROHLÁŠENÍ O SHODĚ
<p>Tímto Yamaha Music Europe GmbH prohlašuje, že typ rádiového zařízení [NU1XA] je v souladu se směrnicí 2014/53/EU. Úplné znění EU prohlášení o shodě je k dispozici na této internetové adrese: https://europe.yamaha.com/en/support/compliance/doc.html</p>	
DA	FORENKLET EU-OVERENSSTEMMELSESERKLÆRING
<p>Hermed erklærer Yamaha Music Europe GmbH, at radioudstypstypen [NU1XA] er i overensstemmelse med direktiv 2014/53/EU. EU-overensstemmelseserklæringens fulde tekst kan findes på følgende internetadresse: https://europe.yamaha.com/en/support/compliance/doc.html</p>	
ET	LIHTSUSTATUD ELI VASTAVUSDEKLARATSIION
<p>Käesolevaga deklareerib Yamaha Music Europe GmbH, et käesolev raadioseadme tüüp [NU1XA] vastab direktiivi 2014/53/EL nõuetele. ELi vastavusdeklaratsiooni täielik tekst on kättesaadav järgmisel internetiaadressil: https://europe.yamaha.com/en/support/compliance/doc.html</p>	

EL	ΑΠΛΟΥΣΤΕΥΜΕΝΗ ΔΗΛΩΣΗ ΣΥΜΜΟΡΦΩΣΗΣ ΕΕ
<p>Με την παρούσα ο/η Yamaha Music Europe GmbH, δηλώνει ότι ο ραδιοεξοπλισμός [NU1XA] πληροί την οδηγία 2014/53/ΕΕ. Το πλήρες κείμενο της δήλωσης συμμόρφωσης ΕΕ διατίθεται στην ακόλουθη ιστοσελίδα στο διαδίκτυο: https://europe.yamaha.com/en/support/compliance/doc.html</p>	
HR	POJEDNOSTAVLJENA EU IZJAVA O SUKLADNOSTI
<p>Yamaha Music Europe GmbH ovime izjavljuje da je radijska oprema tipa [NU1XA] u skladu s Direktivom 2014/53/EU. Cjeloviti tekst EU izjave o sukladnosti dostupan je na sljedećoj internetskoj adresi: https://europe.yamaha.com/en/support/compliance/doc.html</p>	
LV	VIENKĀRŠOTA ES ATBILSTĪBAS DEKLARĀCIJA
<p>Ar šo Yamaha Music Europe GmbH deklarē, ka radioiekārta [NU1XA] atbilst Direktīvai 2014/53/ES. Pilns ES atbilstības deklarācijas teksts ir pieejams šādā interneta vietnē: https://europe.yamaha.com/en/support/compliance/doc.html</p>	
LT	SUPAPRASTINTA ES ATITIKTIES DEKLARACIJA
<p>Aš, Yamaha Music Europe GmbH, patvirtinu, kad radijo įrenginių tipas [NU1XA] atitinka Direktyvą 2014/53/ES. Visas ES atitikties deklaracijos tekstas prieinamas šiuo interneto adresu: https://europe.yamaha.com/en/support/compliance/doc.html</p>	
HU	EGYSZERŰSÍTETT EU-MEGFELELŐSÉGI NYILATKOZAT
<p>Yamaha Music Europe GmbH igazolja, hogy a [NU1XA] típusú rádióberendezés megfelel a 2014/53/EU irányelvnek. Az EU-megfelelőségi nyilatkozat teljes szövege elérhető a következő internetes címen: https://europe.yamaha.com/en/support/compliance/doc.html</p>	
PL	UPROSZCZONA DEKLARACJA ZGODNOŚCI UE
<p>Yamaha Music Europe GmbH niniejszym oświadczam, że typ urządzenia radiowego [NU1XA] jest zgodny z dyrektywą 2014/53/UE. Pełny tekst deklaracji zgodności UE jest dostępny pod następującym adresem internetowym: https://europe.yamaha.com/en/support/compliance/doc.html</p>	
RO	DECLARAȚIA UE DE CONFORMITATE SIMPLIFICATĂ
<p>Prin prezenta, Yamaha Music Europe GmbH declară că tipul de echipamente radio [NU1XA] este în conformitate cu Directiva 2014/53/UE. Textul integral al declarației UE de conformitate este disponibil la următoarea adresă internet: https://europe.yamaha.com/en/support/compliance/doc.html</p>	
SK	ZJEDNODUŠENÉ EÚ VYHLÁSENIE O ZHODE
<p>Yamaha Music Europe GmbH týmto vyhlasuje, že rádiové zariadenie typu [NU1XA] je v súlade so smernicou 2014/53/EÚ. Úplné EÚ vyhlásenie o zhode je k dispozícii na tejto internetovej adrese: https://europe.yamaha.com/en/support/compliance/doc.html</p>	
SL	POENOSTAVLJENA IZJAVA EU O SKLADNOSTI
<p>Yamaha Music Europe GmbH potrjuje, da je tip radijske opreme [NU1XA] skladen z Direktivo 2014/53/EU. Celotno besedilo izjave EU o skladnosti je na voljo na naslednjem spletnem naslovu: https://europe.yamaha.com/en/support/compliance/doc.html</p>	
FI	YKSINKERTAISTETTU EU-VAATIMUSTENMUKAISUUSVAKUUTUS
<p>Yamaha Music Europe GmbH vakuuttaa, että radiolaitetyyppi [NU1XA] on direktiivin 2014/53/EU mukainen. EU-vaatimustenmukaisuusvakuutuksen täysimittainen teksti on saatavilla seuraavassa internetosoitteessa: https://europe.yamaha.com/en/support/compliance/doc.html</p>	
TR	BASITLEŞTİRİLMİŞ AVRUPA BİRLİĞİ UYGUNLUK BİLDİRİMİ
<p>İşbu belge ile, Yamaha Music Europe GmbH, radyo cihaz tipinin [NU1XA], Direktif 2014/53/ AB'ye uygunluğunu beyan eder. AB uyumu beyanının tam metni aşağıdaki internet adresinden edinilebilir: https://europe.yamaha.com/en/support/compliance/doc.html</p>	

(559-M01 RED DoC URL 02)



**Important Notice:
U.S. LIMITED WARRANTY for Customers in the United States**

For detailed information about this Yamaha product and warranty service, please either visit the following website address (printable file is available at our website) or contact Customer Service at the address or telephone number identified below.

Website Address:
Yamaha.io/AvantGrandWarranty

Customer Service:
Yamaha Corporation of America
6600 Orangethorpe Avenue, Buena Park, CA 90620-1273
Telephone: 800-854-1569

Apache License 2.0

Copyright (c) 2009-2018 Arm Limited. All rights reserved.

SPDX-License-Identifier: Apache-2.0

Licensed under the Apache License, Version 2.0 (the License); you may not use this file except in compliance with the License. You may obtain a copy of the License at www.apache.org/licenses/LICENSE-2.0

Unless required by applicable law or agreed to in writing, software distributed under the License is distributed on an AS IS BASIS, WITHOUT WARRANTIES OR CONDITIONS OF ANY KIND, either express or implied. See the License for the specific language governing permissions and limitations under the License.

BSD-3-Clause

The Clear BSD License
Copyright 1997-2016 Freescale Semiconductor, Inc.
Copyright 2016-2018 NXP
All rights reserved.

Redistribution and use in source and binary forms, with or without modification, are permitted (subject to the limitations in the disclaimer below) provided that the following conditions are met:

Redistributions of source code must retain the above copyright notice, this list of conditions and the following disclaimer.

Redistributions in binary form must reproduce the above copyright notice, this list of conditions and the following disclaimer in the documentation and/or other materials provided with the distribution.

Neither the name of the copyright holder nor the names of its contributors may be used to endorse or promote products derived from this software without specific prior written permission.

NO EXPRESS OR IMPLIED LICENSES TO ANY PARTY'S PATENT RIGHTS ARE GRANTED BY THIS LICENSE. THIS SOFTWARE IS PROVIDED BY THE COPYRIGHT HOLDERS AND CONTRIBUTORS "AS IS" AND ANY EXPRESS OR IMPLIED WARRANTIES, INCLUDING, BUT NOT LIMITED TO, THE IMPLIED WARRANTIES OF MERCHANTABILITY AND FITNESS FOR A PARTICULAR PURPOSE ARE DISCLAIMED. IN NO EVENT SHALL THE COPYRIGHT HOLDER OR CONTRIBUTORS BE LIABLE FOR ANY DIRECT, INDIRECT, INCIDENTAL, SPECIAL, EXEMPLARY, OR CONSEQUENTIAL DAMAGES (INCLUDING, BUT NOT LIMITED TO, PROCUREMENT OF SUBSTITUTE GOODS OR SERVICES; LOSS OF USE, DATA, OR PROFITS; OR BUSINESS INTERRUPTION) HOWEVER CAUSED AND ON ANY THEORY OF LIABILITY, WHETHER IN CONTRACT, STRICT LIABILITY, OR TORT (INCLUDING NEGLIGENCE OR OTHERWISE) ARISING IN ANY WAY OUT OF THE USE OF THIS SOFTWARE, EVEN IF ADVISED OF THE POSSIBILITY OF SUCH DAMAGE.

Important Notice: Guarantee Information for customers in European Economic Area (EEA) and Switzerland

<p>Important Notice: Guarantee Information for customers in EEA* and Switzerland</p> <p>For detailed guarantee information about this Yamaha product, and Pan-EEA* and Switzerland warranty service, please either visit the website address below (Printable file is available at our website) or contact the Yamaha representative office for your country. * EEA: European Economic Area</p>	English
<p>Wichtiger Hinweis: Garantie-Information für Kunden in der EWR* und der Schweiz</p> <p>Für nähere Garantie-Information über dieses Produkt von Yamaha, sowie über den Pan-EWR*- und Schweizer Garantieservice, besuchen Sie bitte entweder die folgend angegebene Internetadresse (eine druckfähige Version befindet sich auch auf unserer Webseite), oder wenden Sie sich an den für Ihr Land zuständigen Yamaha-Vertrieb. * EWR: Europäischer Wirtschaftsraum</p>	Deutsch
<p>Remarque importante: informations de garantie pour les clients de l'EEE et la Suisse</p> <p>Pour des informations plus détaillées sur la garantie de ce produit Yamaha et sur le service de garantie applicable dans l'ensemble de l'EEE ainsi qu'en Suisse, consultez notre site Web à l'adresse ci-dessous (le fichier imprimable est disponible sur notre site Web) ou contactez directement Yamaha dans votre pays de résidence. * EEE : Espace Economique Européen</p>	Français
<p>Belangrijke mededeling: Garantie-informatie voor klanten in de EER* en Zwitserland</p> <p>Voor gedetailleerde garantie-informatie over dit Yamaha-product en de garantieservice in heel de EER* en Zwitserland, gaat u naar de onderstaande website (u vindt een afdrukbaar bestand op onze website) of neemt u contact op met de vertegenwoordiging van Yamaha in uw land. * EER: Europese Economische Ruimte</p>	Nederlands
<p>Aviso importante: información sobre la garantía para los clientes del EEE* y Suiza</p> <p>Para una información detallada sobre este producto Yamaha y sobre el soporte de garantía en la zona EEE* y Suiza, visite la dirección web que se incluye más abajo (la versión del archivo para imprimir esta disponible en nuestro sitio web) o póngase en contacto con el representante de Yamaha en su país. * EEE: Espacio Económico Europeo</p>	Español
<p>Avviso importante: informazioni sulla garanzia per i clienti residenti nell'EEA* e in Svizzera</p> <p>Per informazioni dettagliate sulla garanzia relativa a questo prodotto Yamaha e l'assistenza in garanzia nei paesi EEA* e in Svizzera, potete consultare il sito Web all'indirizzo riportato di seguito (è disponibile il file in formato stampabile) oppure contattare l'ufficio di rappresentanza locale della Yamaha. * EEA: Area Economica Europea</p>	Italiano
<p>Aviso importante: informações sobre as garantias para clientes da AEE* e da Suíça</p> <p>Para obter uma informação pormenorizada sobre este produto da Yamaha e o serviço de garantia na AEE* e na Suíça, visite o site a seguir (o arquivo para impressão está disponível no nosso site) ou entre em contato com o escritório de representação da Yamaha no seu país. * AEE: Área Económica Européia</p>	Português
<p>Σημαντική σημείωση: Πληροφορίες εγγύησης για τους πελάτες στον ΕΟΧ* και Ελλάδα</p> <p>Για λεπτομερείς πληροφορίες εγγύησης σχετικά με το παρόν προϊόν της Yamaha και την κάλυψη εγγύησης σε όλες τις χώρες του ΕΟΧ και την Ελλάδα, επισκεφτείτε την παρακάτω ιστοσελίδα (Εκτυπώσιμη μορφή είναι διαθέσιμη στην ιστοσελίδα μας) ή απευθυνθείτε στην αντιπροσωπεία της Yamaha στη χώρα σας. * ΕΟΧ: Ευρωπαϊκός Οικονομικός Χώρος</p>	Ελληνικά
<p>Viktigt: Garantiinformation för kunder i EES-området* och Schweiz</p> <p>För detaljerad information om denna Yamahaprodukt samt garantiservice i hela EES-området* och Schweiz kan du antingen besöka nedanstående webbadress (en utskriftsvänlig fil finns på webbplatsen) eller kontakta Yamahas officiella representant i ditt land. * EES: Europeiska Ekonomiska Samarbetsområdet</p>	Svenska
<p>Viktig merknad: Garantiinformasjon for kunder i EØS* og Sveits</p> <p>Detaljert garantiinformasjon om dette Yamaha-produktet og garantiservice for hele EØS-området* og Sveits kan fås enten ved å besøke nettstedene nedenfor (utskriftsversjon finnes på våre nettsider) eller kontakte Yamahas kontoret i landet der du bor. * EØS: Det europeiske økonomiske samarbeidsområdet</p>	Norsk
<p>Vigtig oplysning: Garantioplysninger til kunder i EØO* og Schweiz</p> <p>De kan finde detaljerede garantioplysninger om dette Yamaha-produkt og den fælles garantiserviceordning for EØO* (og Schweiz) ved at besøge det websted, der er angivet nedenfor (der findes en fil, som kan udskrives, på vores websted), eller ved at kontakte Yamahas nationale repræsentationskontor i det land, hvor De bor. * EØO: Det Europæiske Økonomiske Område</p>	Dansk
<p>Tärkeä ilmoitus: Takuutiedot Euroopan talusalueen (ETA) ja Sveitsin asiakkaille</p> <p>Tämän Yamaha-tuotteen sekä ETA-alueen ja Sveitsin takuuta koskevat yksityiskohtaiset tiedot saatte alla olevasta nettiosoitteesta. (Tulostettava tiedosto saatavissa sivustollamme.) Voitte myös ottaa yhteyttä paikalliseen Yamaha-edustajaan. *ETA: Euroopan talusalue</p>	Suomi
<p>Ważne: Warunki gwarancyjne obowiązujące w EOG* i Szwajcarii</p> <p>Aby dowiedzieć się więcej na temat warunków gwarancyjnych tego produktu firmy Yamaha i serwisu gwarancyjnego w całym EOG* i Szwajcarii, należy odwiedzić wskazaną poniżej stronę internetową (Plik gotowy do wydruku znajduje się na naszej stronie internetowej) lub skontaktować się z przedstawicielstwem firmy Yamaha w swoim kraju. * EOG — Europejski Obszar Gospodarczy</p>	Polski
<p>Důležité oznámení: Záruční informace pro zákazníky v EHS* a ve Švýcarsku</p> <p>Podrobné záruční informace o tomto produktu Yamaha a záručním servisu v celém EHS* a ve Švýcarsku naleznete na níže uvedené webové adrese (soubor k tisku je dostupný na našich webových stránkách) nebo se můžete obrátit na zastoupení firmy Yamaha ve své zemi. * EHS: Evropský hospodářský prostor</p>	Česky
<p>Fontos figyelmeztetés: Garancia-információk az EGT* területén és Svájcban élő vásárlók számára</p> <p>A jelen Yamaha termékre vonatkozó részletes garancia-információk, valamint az EGT*-re és Svájcra kiterjedő garanciális szolgáltatás tekintetében keresse fel webhelyünket az alábbi címen (a webhelyen nyomtatható fájl is talál), vagy pedig lépjen kapcsolatba az országában működő Yamaha képviselői irodával. * EGT: Európai Gazdasági Térség</p>	Magyar
<p>Oluline märkus: Garantiteave Euroopa Majanduspiirkonna (EMP)* ja Šveitsi klientidele</p> <p>Täpsema teabe saamiseks selle Yamaha toote garantii ning kogu Euroopa Majanduspiirkonna ja Šveitsi garantiiteeninduse kohta, külastage palun veebisaiti alljärgneval aadressil (meie saidil on saadaval printitav fail) või pöörduge Teie regiooni Yamaha esinduse poole. * EMP: Euroopa Majanduspiirkond</p>	Eesti keel
<p>Svarīgs paziņojums: garantijas informācija klientiem EEZ* un Šveicē</p> <p>Lai saņemtu detalizētu garantijas informāciju par šo Yamaha produktu, kā arī garantijas apkalpošanu EEZ* un Šveicē, lūdzam apmeklējiet zemāk norādīto tīmekļa vietnes adresi (tīmekļa vietnē ir pieejams drukājams fails) vai zvanieties ar jūsu valsti apkalpojošo Yamaha pārstāvniecību. * EEZ: Eiropas Ekonomikas zona</p>	Latviešu
<p>Děmesio: informacija dėl garantijos pirkėjams EEE* ir Šveicarijoje</p> <p>Jei reikia išsamios informacijos apie šį „Yamaha“ produktą ir jo techninę priežiūrą visoje EEE* ir Šveicarijoje, apsilankykite mūsų svetainėje toliau nurodytu adresu (svetainėje yra spausdintinas failas) arba kreipkitės į „Yamaha“ atstovybę savo šaliai. *EEE – Europos ekonominė erdvė</p>	Lietuvių kalba
<p>Dôležité upozornenie: Informácie o záruke pre zákazníkov v EHP* a Švajčiarsku</p> <p>Podrobné informácie o záruke týkajúce sa tohto produktu od spoločnosti Yamaha a garančnom servise v EHP* a Švajčiarsku nájdete na webovej stránke uvedenej nižšie (na našej webovej stránke je k dispozícii súbor na tlač) alebo sa obráťte na zástupcu spoločnosti Yamaha vo svojej krajine. * EHP: Európsky hospodársky priestor</p>	Slovenčina
<p>Pomembno obvestilo: Informacije o garanciji za kupce v EGP* in Švici</p> <p>Za podrobnejše informacije o tem Yamahinem izdelku ter garancijskem servisu v celotnem EGP in Švici, obiščite spletno mesto, ki je navedeno spodaj (natisljiva datoteka je na voljo na našem spletnem mestu), ali se obrnite na Yamahinega predstavnika v svoji državi. * EGP: Evropski gospodarski prostor</p>	Slovenščina
<p>Важно съобщение: Информация за гаранцията за клиенти в ЕИП* и Швейцария</p> <p>За подробна информация за гаранцията за този продукт на Yamaha и гаранционното обслужване в паневропейската зона на ЕИП* и Швейцария или посетете посочения по-долу уеб сайт (на нашия уеб сайт има файл за печат), или се свържете с представителния офис на Yamaha във вашата страна. * ЕИП: Европейско икономическо пространство</p>	Български език
<p>Notificare importantă: Informații despre garanție pentru clienții din SEE* și Elveția</p> <p>Pentru informații detaliate privind acest produs Yamaha și serviciul de garanție Pan-SEE* și Elveția, vizitați site-ul la adresa de mai jos (fișierul imprimabil este disponibil pe site-ul nostru) sau contactați biroul reprezentanței Yamaha din țara dumneavoastră. * SEE: Spațiul Economic European</p>	Limba română
<p>Važna obavijest: Informacije o jamstvu za države EGP-a i Švicarske</p> <p>Za detaljne informacije o jamstvu za ovaj Yamahin proizvod te jamstvenom servisu za cijeli EGP i Švicarsku, molimo Vas da posjetite web-stranicu navedenu u nastavku ili kontaktirate ovlaštenog Yamahinog dobavljača u svojoj zemlji. * EGP: Europski gospodarski prostor</p>	Hrvatski

<https://europe.yamaha.com/warranty/>

For details of products, please contact your nearest Yamaha representative or the authorized distributor listed below.

Pour plus de détails sur les produits, veuillez-vous adresser à Yamaha ou au distributeur le plus proche de vous figurant dans la liste suivante.

Para detalles sobre productos, contacte su tienda Yamaha más cercana o el distribuidor autorizado que se lista debajo.

NORTH AMERICA

CANADA

Yamaha Canada Music Ltd.
135 Milner Avenue, Toronto, Ontario M1S 3R1,
Canada
Tel: +1-416-298-1311

U.S.A.

Yamaha Corporation of America
6600 Orangefhorpe Avenue, Buena Park,
CA 90620, U.S.A.
Tel: +1-714-522-9011

CENTRAL & SOUTH AMERICA

MEXICO

Yamaha de México, S.A. de C.V.
Av. Insurgentes Sur 1647 Piso 9, Col. San José
Insurgentes, Delegación Benito Juárez, CDMX,
C.P. 03900, México
Tel: +52-55-5804-0600

BRAZIL

Yamaha Musical do Brasil Ltda.
Praça Professor José Lannes, 40-Cjs 21 e 22,
Brooklin Paulista Novo CEP 04571-100 – São
Paulo – SP, Brazil
Tel: +55-11-3704-1377

ARGENTINA

**Yamaha Music Latin America, S.A.,
Sucursal Argentina**
Olga Cossetini 1553, Piso 4 Norte,
Madero Este-C1107CEK,
Buenos Aires, Argentina
Tel: +54-11-4119-7000

PANAMA AND OTHER LATIN AMERICAN REGIONS/CARIBBEAN REGIONS

Yamaha Music Latin America, S.A.
Edificio Torre Davivienda, Piso: 20 Avenida
Balboa, Marbella, Corregimiento de Bella Vista,
Ciudad de Panamá, Rep. de Panamá
Tel: +507-269-5311

EUROPE

THE UNITED KINGDOM/IRELAND

Yamaha Music Europe GmbH (UK)
Sherbourne Drive, Tilbrook, Milton Keynes,
MK7 8BL, U.K.
Tel: +44-1908-366700

GERMANY

Yamaha Music Europe GmbH
Siemensstrasse 22-34, 25462 Rellingen, Germany
Tel: +49-4101-303-0

SWITZERLAND/LIECHTENSTEIN

**Yamaha Music Europe GmbH, Branch
Switzerland in Thailand**
Seestrasse 18a, 8800 Thalwil, Switzerland
Tel: +41-44-3878080

AUSTRIA/CROATIA/CZECH REPUBLIC/ HUNGARY/ROMANIA/SLOVAKIA/ SLOVENIA

Yamaha Music Europe GmbH, Branch Austria
Schleiergasse 20, 1100 Wien, Austria
Tel: +43-1-60203900

POLAND

**Yamaha Music Europe
Sp.z o.o. Oddział w Polsce**
ul. Młynarska 48, 01-171 Warszawa, Poland
Tel: +48-22-880-08-88

BULGARIA

Dinacord Bulgaria LTD.
Bul.Iskarsko Schose 7 Targowski Zentar
Ewropa 1528 Sofia, Bulgaria
Tel: +359-2-978-20-25

MALTA

Olimpus Music Ltd.
Valletta Road, Mosta MST9010, Malta
Tel: +356-2133-2093

NETHERLANDS/BELGIUM/ LUXEMBOURG

Yamaha Music Europe, Branch Benelux
Wattbaan 1 3439ML Nieuwegein,
The Netherlands
Tel: +31-347-358040

FRANCE

Yamaha Music Europe
7 rue Ambroise Croizat, Zone d'activités de
Pariest, 77183 Croissy-Beaubourg, France
Tel: +33-1-6461-4000

ITALY

Yamaha Music Europe GmbH, Branch Italy
Via Tinelli N.67/69 20855 Gemo di Lesmo (MB),
Italy
Tel: +39-039-9065-1

SPAIN/PORTUGAL

**Yamaha Music Europe GmbH Ibérica,
Sucursal en España**
Ctra. de la Coruña km. 17,200, 28231
Las Rozas de Madrid, Spain
Tel: +34-91-639-88-88

GREECE

Philippos Nakas S.A. The Music House
19th km. Leof. Lavriou 190 02 Peania – Attiki,
Greece
Tel: +30-210-6686260

SWEDEN

**Yamaha Music Europe GmbH Germany Filial
Scandinavia**
JA Wettergrensgata 1, 400 43 Göteborg, Sweden
Tel: +46-31-89-34-00

DENMARK

**Yamaha Music Denmark,
Fillial of Yamaha Music Europe GmbH, Tyskland**
Generatorvej 8C, ST. TH., 2860 Søborg, Denmark
Tel: +45-44-92-49-00

FINLAND

F-Musiikki Oy
Antaksentie 4
FI-01510 Vantaa, Finland
Tel: +358 (0)96185111

NORWAY

**Yamaha Music Europe GmbH Germany -
Norwegian Branch**
c/o Box 30053, 400 43 Göteborg, Sweden
Tel: +47-6716-7800

ICELAND

Hljodfaerahusid Ehf.
Sidumula 20
IS-108 Reykjavik, Iceland
Tel: +354-525-5050

CYPRUS

Nakas Music Cyprus Ltd.
Nikis Ave 2k
1086 Nicosia
Tel: +357-22-511080
Major Music Center
21 Ali Riza Ave. Ortakoy
P.O.Box 475 Lefkoşa, Cyprus
Tel: (392) 227 9213

RUSSIA

Yamaha Music (Russia) LLC.
Room 37, entrance 7, bld. 7, Kievskaya street,
Moscow, 121059, Russia
Tel: +7-495-626-5005

OTHER EUROPEAN REGIONS

Yamaha Music Europe GmbH
Siemensstrasse 22-34, 25462 Rellingen, Germany
Tel: +49-4101-303-0

AFRICA

Yamaha Music Gulf FZE
JAFZA-16, Office 512, P.O.Box 17328,
Jebel Ali FZE, Dubai, UAE
Tel: +971-4-801-1500

MIDDLE EAST

TURKEY

Dore Muzik
Yeni Sülün Sokak No. 10
Levent İstanbul / Türkiye
Tel: +90-212-236-3640
Fax: +90-212-259-5567

ISRAEL

RBX International Co., Ltd.
P.O.Box 10245, Petach-Tikva, 49002
Tel: (972) 3-925-6900

OTHER REGIONS

Yamaha Music Gulf FZE
JAFZA-16, Office 512, P.O.Box 17328,
Jebel Ali FZE, Dubai, UAE
Tel: +971-4-801-1500

ASIA

THE PEOPLE'S REPUBLIC OF CHINA

Yamaha Music & Electronics (China) Co., Ltd.
2F, Yunhedasha, 1818 Xinzha-lu, Jingnan-qu,
Shanghai, China
Tel: +86-400-051-7700

HONG KONG

Tom Lee Music Co., Ltd.
11/F., Silvercord Tower 1, 30 Canton Road,
Tsimshatsui, Kowloon, Hong Kong
Tel: +852-2737-7688

INDIA

Yamaha Music India Private Limited
P-401, JMD Megapolis, Sector-48, Sohna Road,
Gurugram-122018, Haryana, India
Tel: +91-124-485-3300

INDONESIA

PT Yamaha Musik Indonesia Distributor
Yamaha Music Center Bldg. Jalan Jend. Gatot
Subroto Kav. 4, Jakarta 12930, Indonesia
Tel: +62-21-520-2577

KOREA

Yamaha Music Korea Ltd.
11F, Prudential Tower, 298, Gangnam-daero,
Gangnam-gu, Seoul, 06253, Korea
Tel: +82-2-3467-3300

MALAYSIA

Yamaha Music (Malaysia) Sdn. Bhd.
No.8, Jalan Perbandaran, Kelana Jaya, 47301
Petaling Jaya, Selangor, Malaysia
Tel: +60-3-78030900

SINGAPORE

Yamaha Music (Asia) Private Limited
Block 202 Hougang Street 21, #02-00,
Singapore 530202, Singapore
Tel: +65-6740-9200

TAIWAN

Yamaha Music & Electronics Taiwan Co., Ltd.
2F., No.1, Yuandong Rd., Banqiao Dist.,
New Taipei City 22063, Taiwan (R.O.C.)
Tel: +886-2-7741-8888

THAILAND

Siam Music Yamaha Co., Ltd.
3, 4, 15, 16th Fl., Siam Motors Building,
89/1/1 Rama 1 Road, Wangmai,
Pathumwan, Bangkok 10330, Thailand
Tel: +66-2215-2622

VIETNAM

Yamaha Music Vietnam Company Limited
15th Floor, Nam A Bank Tower, 201-203 Cach
Mang Thang Tam St., Ward 4, Dist.3,
Ho Chi Minh City, Vietnam
Tel: +84-28-3818-1122

OTHER ASIAN REGIONS

<https://asia.yamaha.com/>

OCEANIA

AUSTRALIA

Yamaha Music Australia Pty. Ltd.
Level 1, 80 Market Street, South Melbourne,
VIC 3205 Australia
Tel: +61-3-9693-5111

NEW ZEALAND

Music Works LTD
P.O.BOX 6246 Wellesley, Auckland 4680,
New Zealand
Tel: +64-9-634-0099

REGIONS AND TRUST TERRITORIES IN PACIFIC OCEAN

<https://asia.yamaha.com/>

Head Office/Manufacturer: Yamaha Corporation 10-1, Nakazawa-cho, Naka-ku, Hamamatsu, 430-8650, Japan

Importer (European Union): Yamaha Music Europe GmbH Siemensstrasse 22-34, 25462 Rellingen, Germany

Importer (United Kingdom): Yamaha Music Europe GmbH (UK) Sherbourne Drive, Tilbrook, Milton Keynes, MK7 8BL, United Kingdom

DMI31

Yamaha Global Site
<https://www.yamaha.com/>

Yamaha Downloads
<https://download.yamaha.com/>

© 2023 Yamaha Corporation
Published 02/2023
MWMA-A0



VFN5940